

# RBR *glissando* UNDERWAY PROFILING WINCH GUIDE



[rbr-global.com](http://rbr-global.com)

# Table of contents

1	RBRglissando.....	4
1.1	Drum unit.....	5
1.2	Sheave unit.....	6
1.3	Control cabinet .....	7
2	Specifications.....	8
3	Operation .....	9
4	Using Ruskin.....	10
5	Setting up the RBRglissando .....	11
5.1	Unpacking the RBRglissando .....	11
5.2	Mounting the drum unit.....	16
5.3	Connecting the cables .....	16
5.4	Powering the RBRglissando .....	18
5.5	Connecting to Ruskin.....	19
5.6	Feeding the line through the units.....	21
5.7	Mounting the sheave unit.....	26
6	Configuring the RBRglissando.....	27
7	Using the Wi-Fi module.....	28
8	Setting up an instrument.....	30
9	Setting up automated profiling.....	35
9.1	Home position.....	35
9.2	Winch cycle.....	37
9.3	Example of automated profiling .....	41
9.4	Automatic downloads.....	44
9.5	Plot window.....	46

10	Operating in manual mode on Ruskin .....	47
11	Manual controls on the winch .....	49
11.1	Cabinet control unit .....	49
11.2	Handheld remote control unit .....	50
12	Maintenance.....	52
12.1	Regular maintenance.....	52
12.2	Setting up manual speeds .....	52
12.3	Removing the line from the drum .....	53
12.4	Setting a drum limit .....	54
12.5	Respooling the line onto the drum .....	56
13	Troubleshooting.....	58
13.1	Error indicators on the winch .....	58
13.2	Error indicators on Ruskin .....	59
14	Revision history .....	61

# 1 RBRglissando

The RBR*glissando* underway winch enables automated free-fall profiling with instrument payloads up to 20kg. A configurable line speed up to 10m/s allows for operation while steaming normally without slowing down. This fully-automated system is designed for vessels with an existing A-frame or boom, and three-phase power supplies. The compact design is easy to install and occupies minimal deck space. The RBR*glissando* is controlled by the RBR software, Ruskin, offering wireless downloads after each profile and integration of ship and winch data.

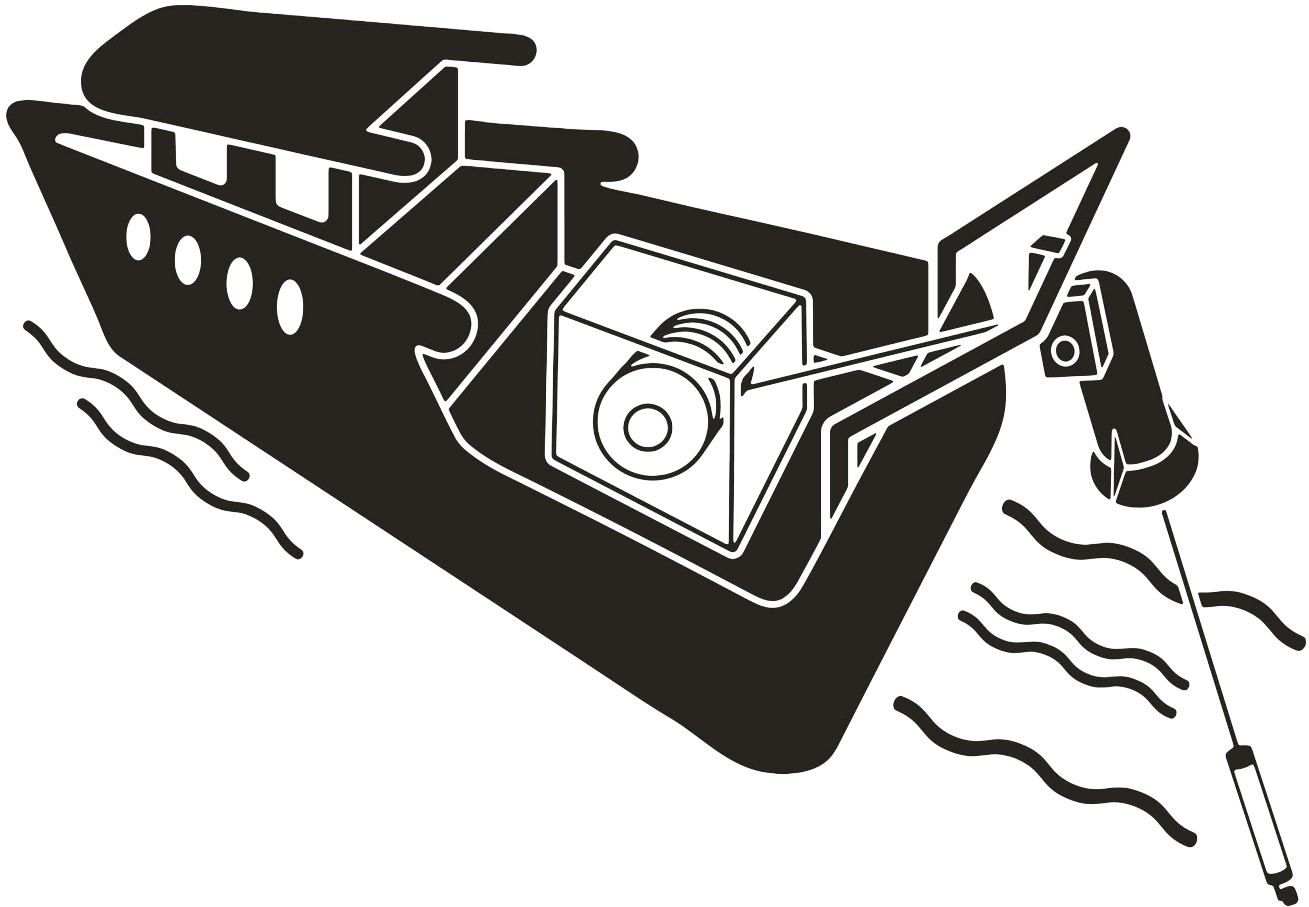

The RBR*glissando* consists of a drum unit, a sheave unit, and a control cabinet. The stationary drum unit and the control cabinet remain on the vessel or dock, the former bolted or strapped in place and the latter relatively mobile. The sheave unit is mounted above the water. An electric motor turns the drum and provides the lifting force to the winch. The Dyneema® line unspools from the drum and moves rapidly when launching an instrument. At a rare event of the line becoming entangled during operation, the RBR*glissando* will trigger an emergency stop. The winch applies an automatic speed throttle at the termination depth and at the surface, and shuts off automatically when the instrument is in the bell mouth.

**⚠** When mounting the winch, make sure to align the drum unit on the deck and the sheave unit on its A-frame.

## 1.1 Drum unit

The drum unit contains the drum, the main motor, and the spooling device. Mount it on the deck, securing in position with four bolts or ratchet straps.

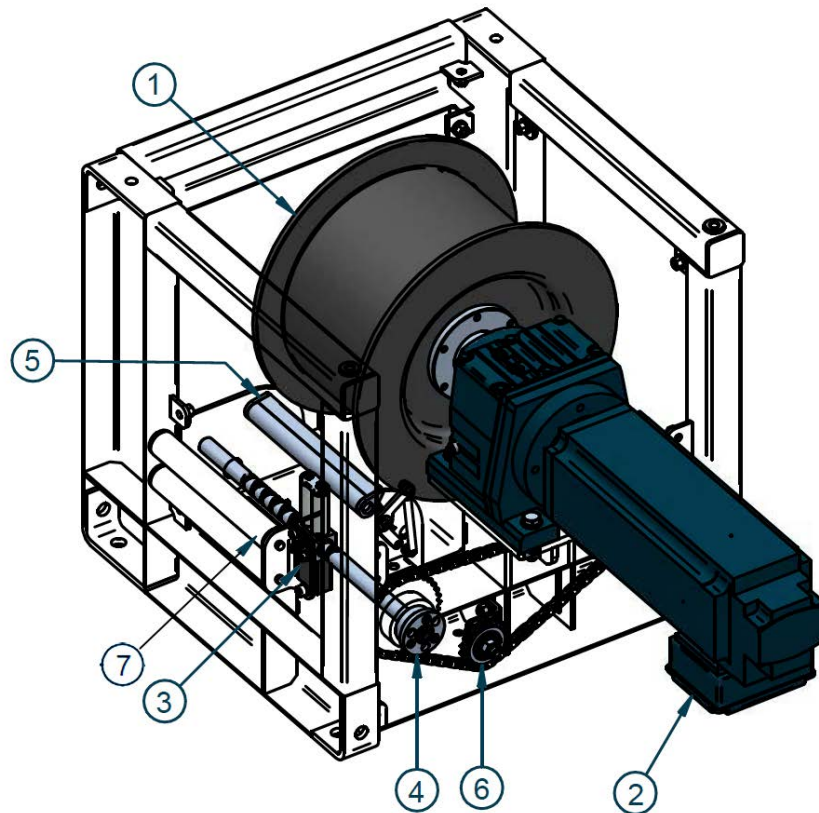

**Drum unit, transparent view**

1. **Drum** – Holds the wire
2. **Main motor** – Turns the drum and provides the lifting force
3. **Line winder** – Distributes the line evenly over the drum
4. **Line winder adjuster** – Adjusts the position of the line winder
5. **Tangled line detector** – Detects a severely tangled wire
6. **Chain tensioner** – One on each side
7. **Line rollers** – Direct the line out of the drum

## 1.2 Sheave unit

The sheave unit features a small motor to keep the line tensioned between the sheave and the drum.

Mount the sheave unit above the water on an A-frame or a boom, in line with the drum unit. When extending or retracting the A-frame, keep the line slack at all times.

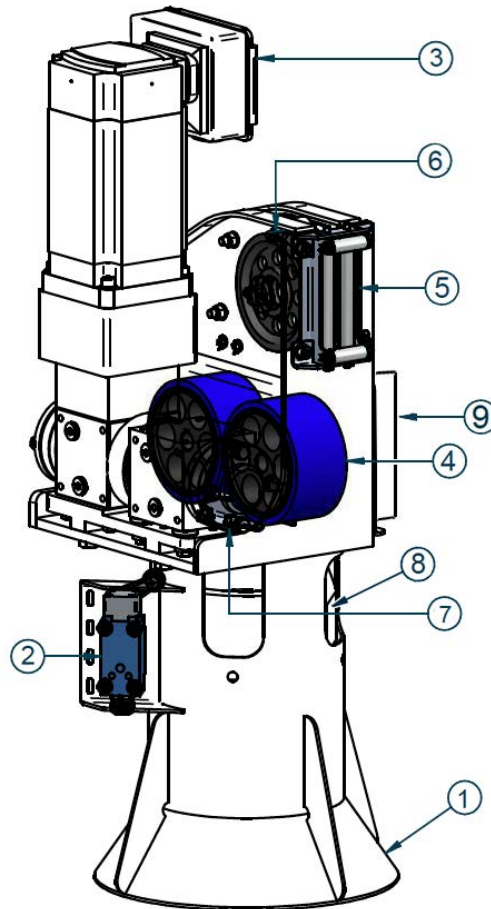

**Sheave unit, transparent view**

1. **Bell mouth** – Holds the instrument when it is retrieved
- 2 **Bell mouth switch** – Detects the presence of the instrument
3. **Line tensioner motor** – Drives the line tensioner rollers
4. **Line tensioner rollers** – Keep tension on the rope during spooling and unspooling
5. **Fairlead** – Entry point of the sheave unit
6. **Sheave wheel** – Guides the line to the line tensioner rollers
7. **Line exit guide** – Guides the line at the exit
8. **End-cap cradle** – Cradles the instrument end-cap inside the bell mouth; activates the drum limit switch
9. **RBRcervello box** – Contains the RBRcervello data controller for extended memory and data hosting option

## 1.3 Control cabinet

Place the control cabinet on a trolley to maintain its mobility, or securely mount it to the deck. Wire the supply and control interface cables through the connectors provided at the bottom of the control cabinet and junction boxes.

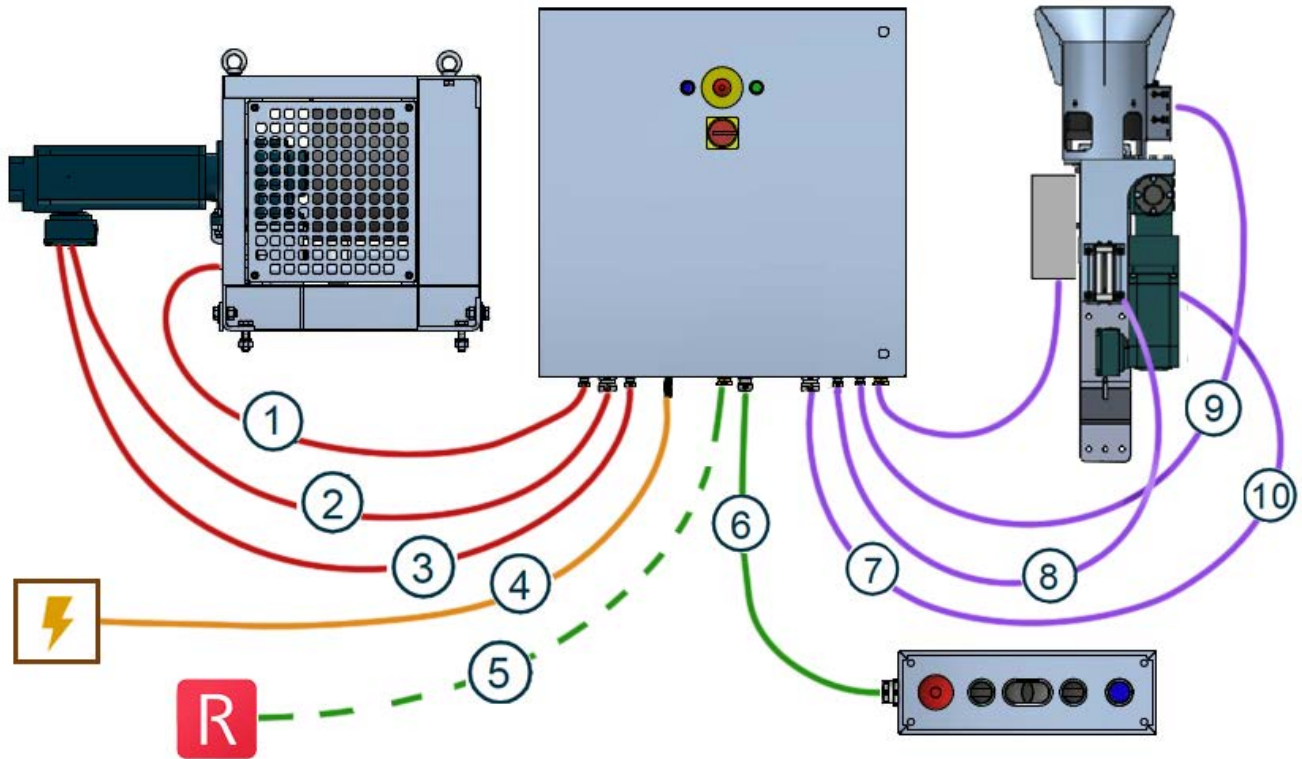

**Control cabinet with cable wiring schematics**

1. **To drum limit switch** – Activates the drum limit switch
- 2 **To drum motor** – Supplies power to the drum motor
3. **To drum encoder** – Communicates with the drum encoder
4. **To power source** – Powers up the control cabinet, compatible with outlets of 400-480V 3 $\phi$  AC
5. **To Ruskin** – Standard Ethernet cable (not included)
6. **To handheld remote** – Connects to the handheld remote control unit
7. **To sheave motor** – Supplies power to the sheave motor
8. **To sheave encoder** – Communicates with the sheave encoder
9. **To bell mouth switch** – Communicates with the bell mouth
10. **To RBRcervello box** – Communicates with the RBRcervello data controller via Ethernet

## 2 Specifications

### Power and communication

Supply voltage	400-480V 3ø AC
Power consumption	15kW drum motor, 4kW sheave motor
Interface	Ethernet
Software	Ruskin

### Mechanical

Dimensions	
Drum unit	1030mm x 610mm x 560mm
Sheave unit	870mm x 330mm x 360mm
Control cabinet	770mm x 790mm x 410mm
Weight	
Drum unit	170kg
Sheave unit	70kg
Control cabinet	80kg

### Operation

Line type	ø3mm Dyneema
Line length	1000m
Line speed	10m/s pay out, 5m/s wind in
Nominal payload	20kg
Line strength	1000kg



## 3 Operation

⚠ Before using the winch, verify that the drum unit is securely mounted.

⚠ When extending or retracting the A-frame with the sheave unit, keep the line slack at all times.

⚠ During operation, stay clear of the line between the drum unit and the sheave unit. In launch mode, it will move rapidly and should not be touched or grabbed.

⚠ Ensure you have access to the **Emergency stop** button on the control cabinet and/or the handheld remote at all times.

Fully supported on Ruskin, the *RBRglissando* is easy to configure. Set up automated profiling with up to five depth and speed combinations and launch the winch via Ethernet. In manual mode, use **Wind in / Pay out** buttons on the screen of your computer to dispense the line slowly. Ruskin will track the line speed and length in an RSK file.

Additionally, take advantage of manual controls located on the control cabinet and the handheld remote, including the **ON / OFF** switch, **Emergency stop** button, and **RESET** button. These will allow you to operate the *RBRglissando* even when your computer is temporarily unavailable.

## 4 Using Ruskin

Ruskin is the only tool you need to manage all your RBR instruments and measurement data, as well as the RBR*glissando*. Associate your instrument with the winch for seamless operation.

For a detailed description on how to install and update Ruskin, see Ruskin User Guide: Standard Instruments<sup>3</sup>, sections 1-4 (available on the RBR website or on Ruskin, **Help > Documentation**).

Ruskin software has a user-friendly interface which consists of a **Toolbar** and three main windows: **Navigator**, **Properties**, and **Plot**.

### Toolbar

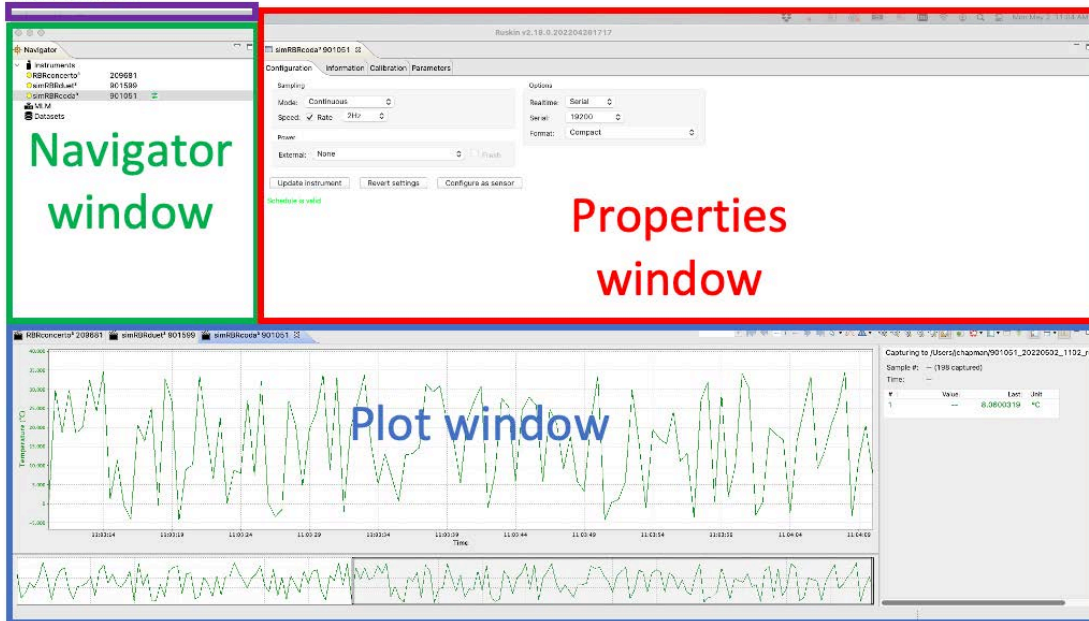

The **Toolbar** at the top left above the **Navigator** window has four dropdown menus. If you are using a Mac computer, it appears as follows:

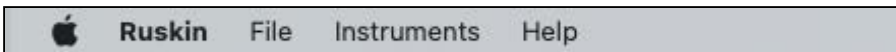

On a Windows PC, the **Toolbar** looks slightly differently:

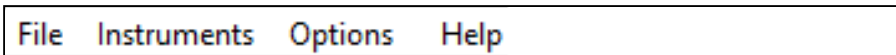

The rest of the interface is the same between the two systems.

## 5 Setting up the RBRglissando

Your RBR*glissando* is shipped in a single crate, with the three units packed individually. Setting up your winch involves unpacking and mounting the units, wiring the cables to the control cabinet, feeding the line from the drum to the sheave, and connecting to Ruskin.

### 5.1 Unpacking the RBRglissando

The RBR*glissando* arrives in a crate, where all units are packed together. Each unit comes with a set of cables bundled together in a protective sleeve. When you order an RBR instrument at the same time, the case with the instrument will also be included inside the crate. Follow the steps below to unpack your winch.

 Do not remove protective sleeves from bundled cables.

#### Steps

1. Remove the top and walls of the crate.
2. Remove all the protective foam from the top and dispose of it responsibly.
3. Remove the case with the RBR instrument (1, if applicable), the box with the handheld remote control unit (2), and the support kit box (3, behind the drum unit).

 The support kit contains the Allen keys for opening up the drum and sheave units for line feeds, and other hardware.

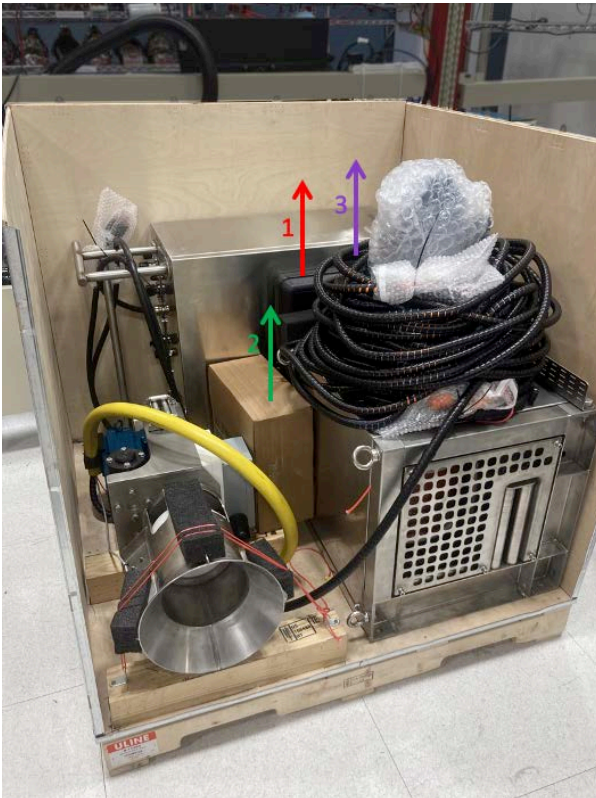

4. Unfasten the sheave:
  - \* Remove the Dyneema line holding the bell mouth
  - \* Unscrew the bolt securing the sheave to the second wood block

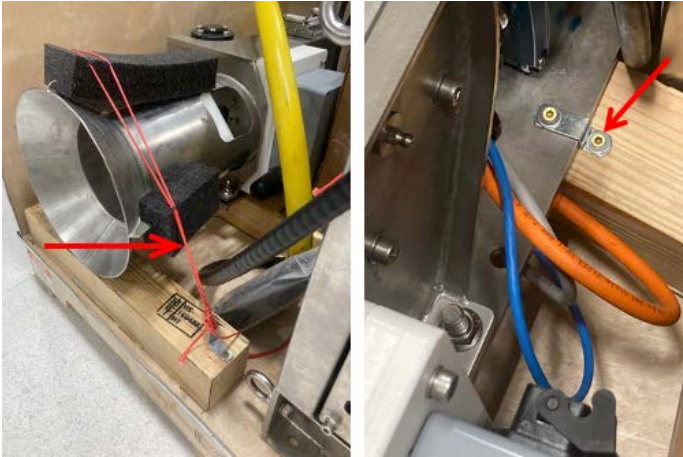

5. Remove the sheave unit from the pallet.

⚠ The sheave unit weighs 70kg. You need at least two people to lift it.

The drum unit and the control cabinet, which are simply sitting on the pallet, are now accessible.



6. Identify a spot on the deck where you will install the control cabinet.

**⚠** The control cabinet ships positioned on its side. It will need to be in the proper orientation for installation and connection.

7. Remove the control cabinet from the pallet and place it at the selected spot in the proper orientation, to prepare for connecting.

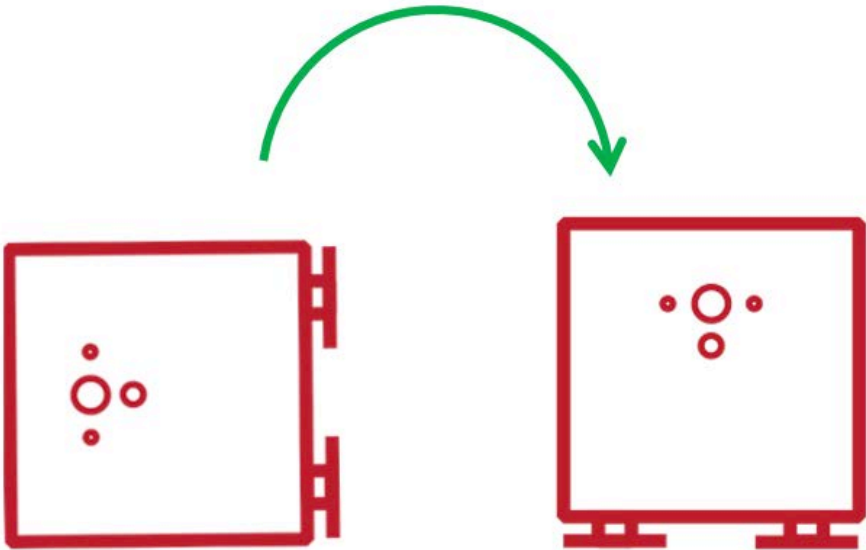

**⚠** The control cabinet weighs 80kg. You need at least two people to lift it.

**⚠** Do not cut the zip-ties from the cable and do not remove the bubble wrap from the connector until you are done positioning the cabinet and ready to connect.

8. Locate the key to the control cabinet, zip-tied to the Mains switch.

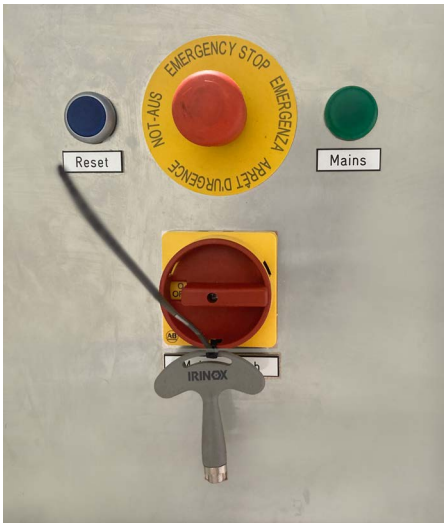



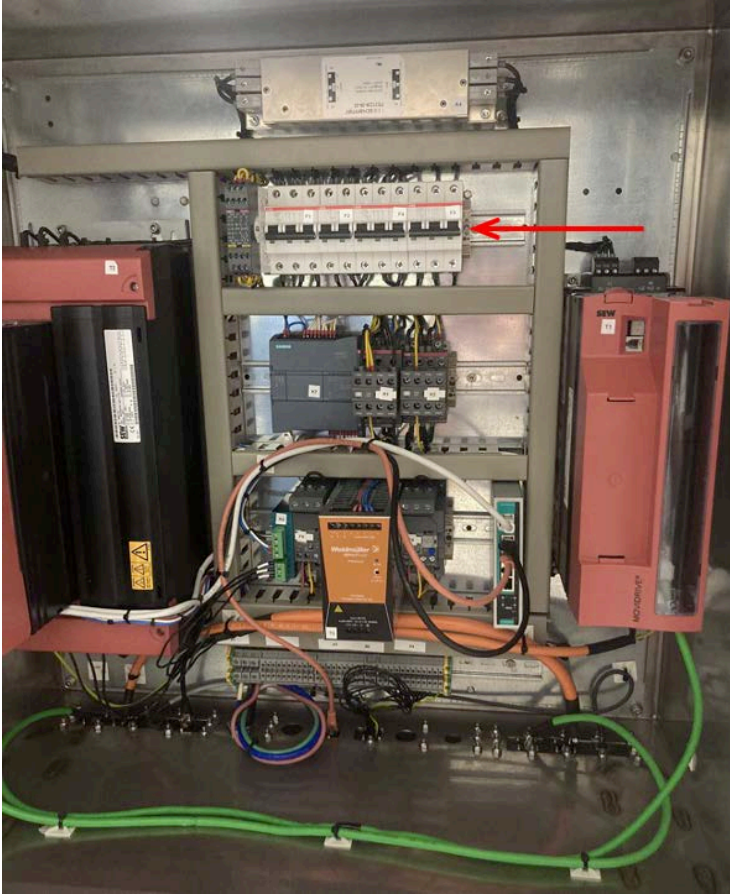

9. Open the control cabinet using the key and locate the fuse box.



10. Flip all the breakers on.
11. Close and lock the control cabinet.

 The control cabinet should remain locked at all times. The only reason to open it would be to reset the breakers when they trip.

12. Identify a convenient spot on the deck in line with the A-frame to install the drum unit.

 The drum unit ships with the motor oriented upwards. It will need to be in the proper orientation for installation and connection.



13. Remove the drum unit from the pallet and place it at the selected spot in the proper orientation, to prepare for mounting.

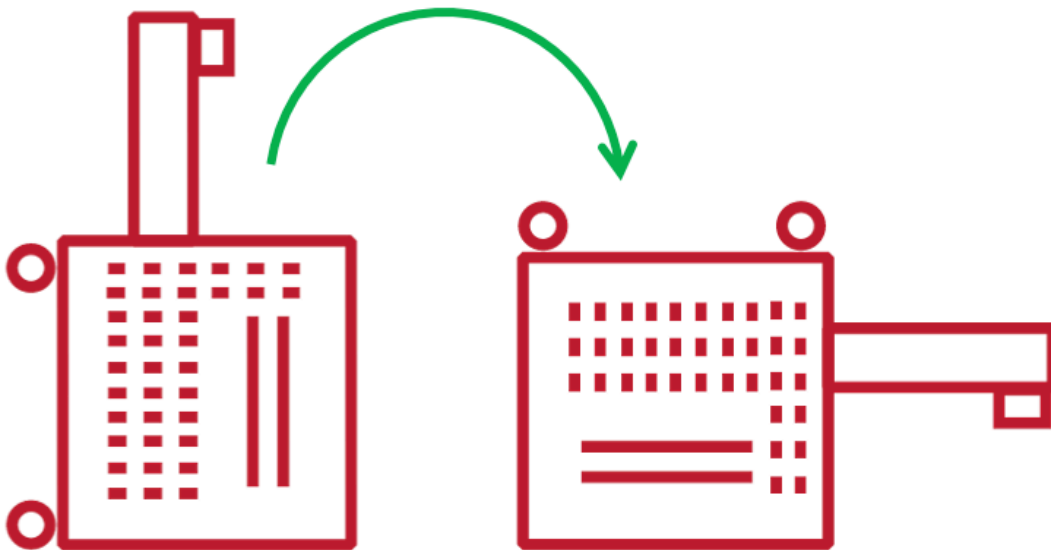

⚠ The drum unit weighs 170kg. You need at least four people to lift it.

⚠ Do not cut the zip-ties from the cable and do not remove the bubble wrap from the connector until you are done positioning the drum and ready to connect.

## 5.2 Mounting the drum unit

Identify a convenient spot in line with the A-frame. Mount the drum unit on the deck, securing in position with four bolts or ratchet straps.



**⚠** Verify that the drum is securely mounted before proceeding to the next step.

## 5.3 Connecting the cables

After unpacking the RBR*glissando* and mounting the drum unit on the deck, proceed with connecting the power and communication cables to the control cabinet.

The drum unit comes with three hardwired cables and the sheave unit, with four. The handheld remote control unit has one hardwired cable.

**⚠** The Ethernet cable for Ruskin is not included. Use a standard Ethernet cable with the length that suits your needs.

Turn the control cabinet to the side to access the three panels, **Drum**, **Controls**, and **Sheave**. Plug each cable into its designated connector as indicated on the diagram below.



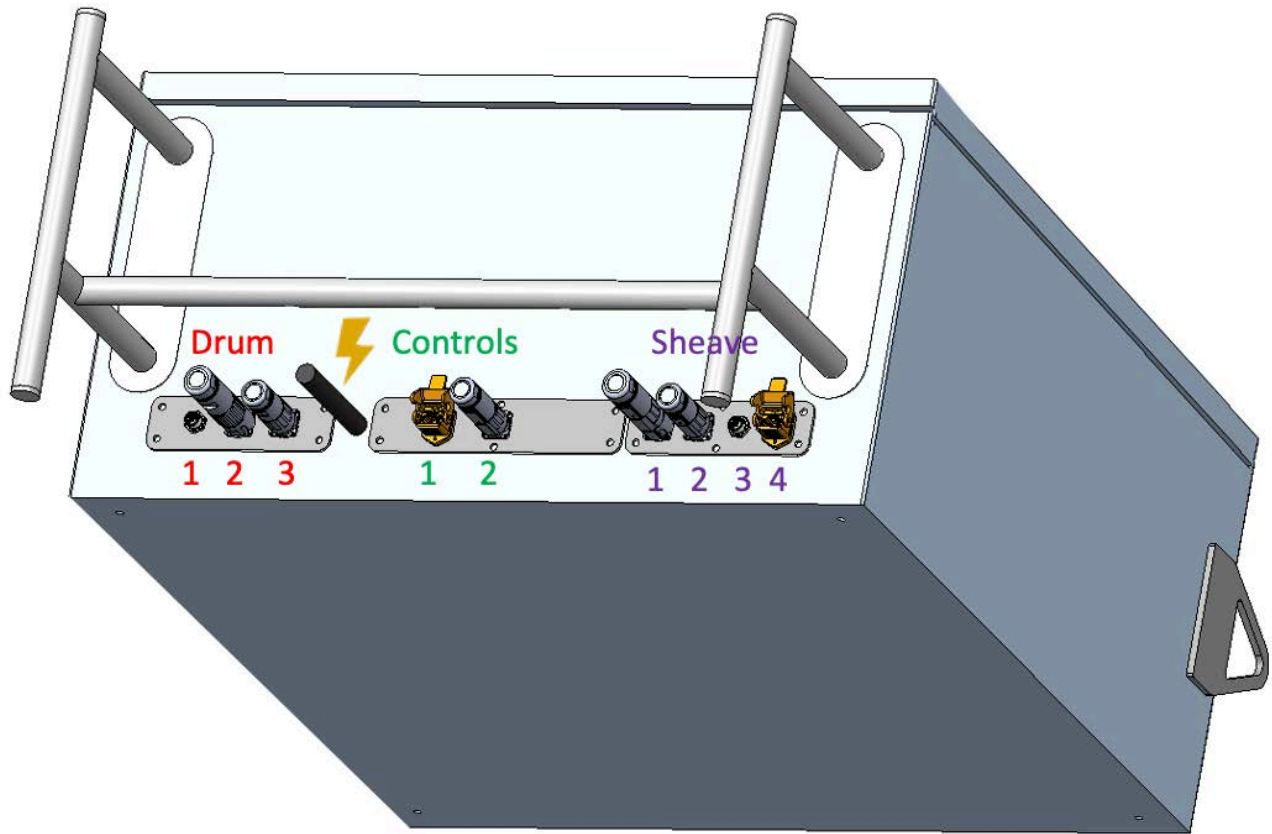

### Drum

1. Drum limit switch
2. Power to drum motor
3. Drum encoder

### Controls

1. Ethernet to Ruskin
2. Handheld remote

### Sheave

1. Power to sheave motor
2. Sheave encoder
3. Bell mouth switch
4. Ethernet to RBRcervello

The power cable for the control cabinet is hardwired to its power connector . Plug it in (400-480V 3Ø AC) only after all the other cables are connected to the control cabinet.

## 5.4 Powering the RBRglissando

With the power cables now connected to the control cabinet, you can power the winch.

### Steps

1. Plug in the control cabinet power cable to the compatible power outlet (400-480V 3Ø AC).
2. Turn the **Mains switch** on the control cabinet to the **ON** position, then push **Reset**.



3. Verify that the **ON /OFF** switch on the handheld remote control is also in the **ON** position. If it is in the **OFF** position, turn it to **ON** and push **RESET**. Otherwise, proceed to the next step.



## 5.5 Connecting to Ruskin

After the RBR*glissando* power and communication cables are connected to the control cabinet, turn the power switch on. Now you can connect the winch to Ruskin.

### Steps

1. Connect the Ethernet cable from the control cabinet to your laptop.
2. Configure a dedicated Ethernet port on your machine for the RBR*glissando* with the IP address: **192.168.100.100**.

 To set a static IP address on your machine, refer to applicable documentation for your particular operating system.

3. On the handheld remote control, turn the **LOCAL / REMOTE** switch to the **REMOTE** position. When it is, the white LED will be off.



 If Ruskin is already installed and running on your laptop, proceed to [Connecting to the RBR\*glissando\*](#). If not, go to [Using Ruskin](#) for guidance.

4. Right-click **Winches** in the **Navigator** window to connect to the RBR*glissando*.



5. Enter 192.168.100.255 in the **IP address** field and 2000 for the **IP port**, then click **Connect**.



Your RBRglissando information will appear in the **Navigator** window, with the **Properties** window becoming **Control**, with three tabs: **Manual**, **Profiling**, and **Configuration**.

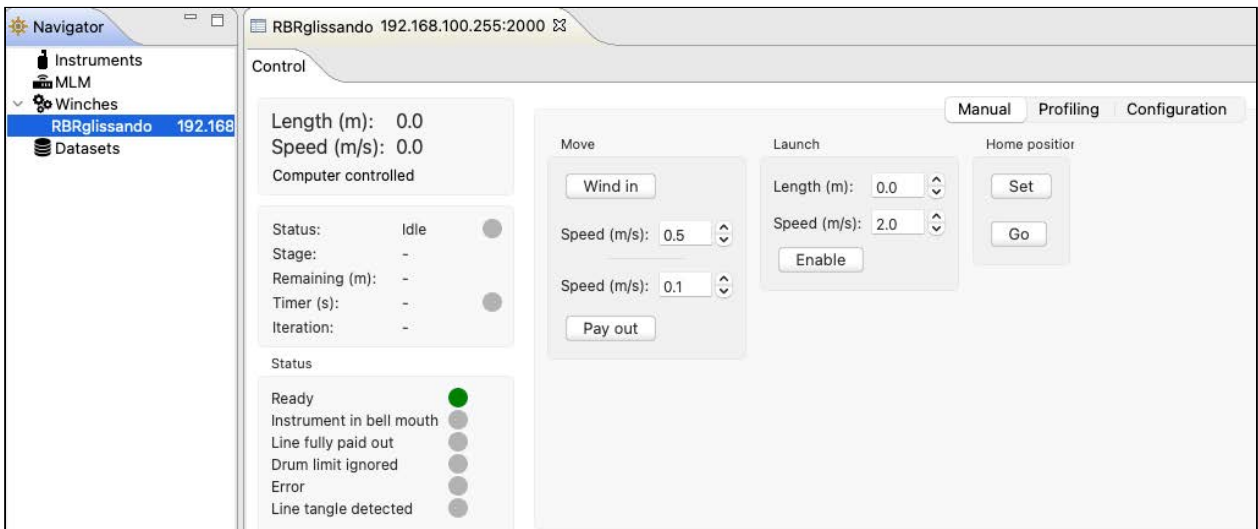

You will use the three tabs to configure and operate your RBRglissando. The three subsections on the left remain the same for all tabs and display various statuses of the winch.

6. Verify your connection.

If the RBRglissando is connected to Ruskin, a message "Computer controlled" will be displayed in the top left subsection.

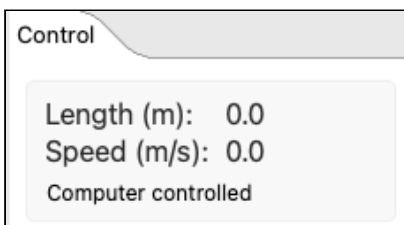

If the message reads, "Handheld remote controlled", the **LOCAL / REMOTE** switch on the [handheld remote](#) must be in the **LOCAL** position. Turn the switch to **REMOTE**, and the RBRglissando will connect to Ruskin immediately.

## 5.6 Feeding the line through the units

When the drum unit is securely mounted and the winch has power, feed the line through the units.

**i** With some A-frames, you may be able to mount and secure the sheave to the A-frame first, then feed the line to it.

### Steps

1. Turn the power off using either the **Mains switch** on the control cabinet or the **ON /OFF** switch on the handheld remote control.
2. Ensure the **LOCAL / REMOTE** switch is still in the **REMOTE** position.
3. Unscrew and remove the cover from the drum.

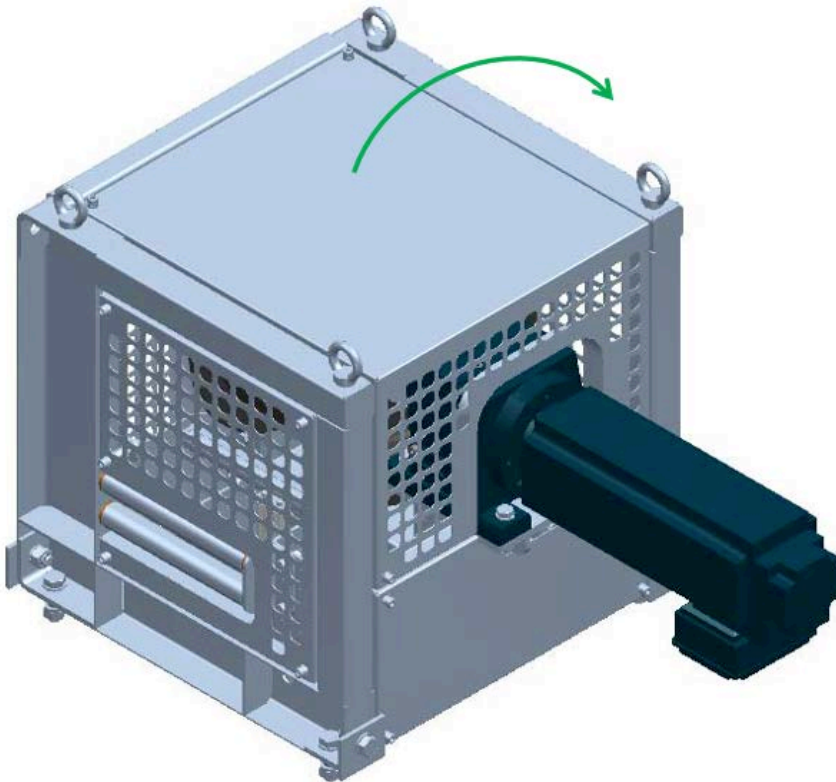

4. Remove the plastic tape from the line inside the drum and locate the end.

**⚠** An insertion tool is taped to the end of the line. Leave it there until the units are connected. It will help you insert the line between rollers.

- Run the line from the drum through the level winders to the line rollers and out of the drum, about 30cm.

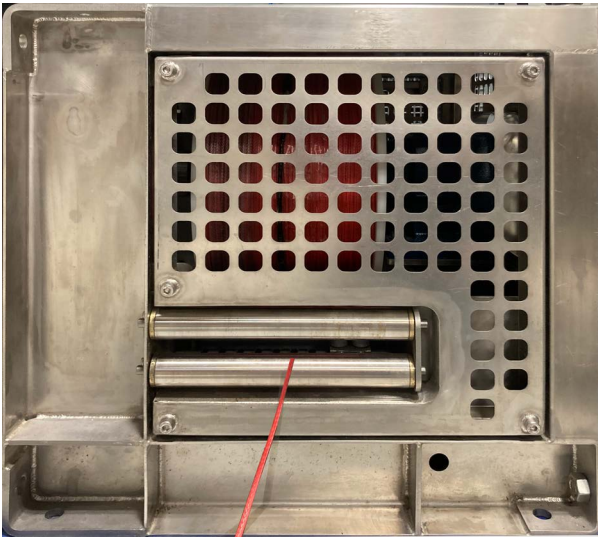

- Turn the power on and push **RESET** on the handheld remote control.
- On Ruskin, reconnect to the winch.
- Under **Move**, set the pay-out speed to 0.1m, then click **Pay out** several times to dispense enough line to reach the sheave.

 See [Operating in manual mode on Ruskin](#) for more guidance on using these options.

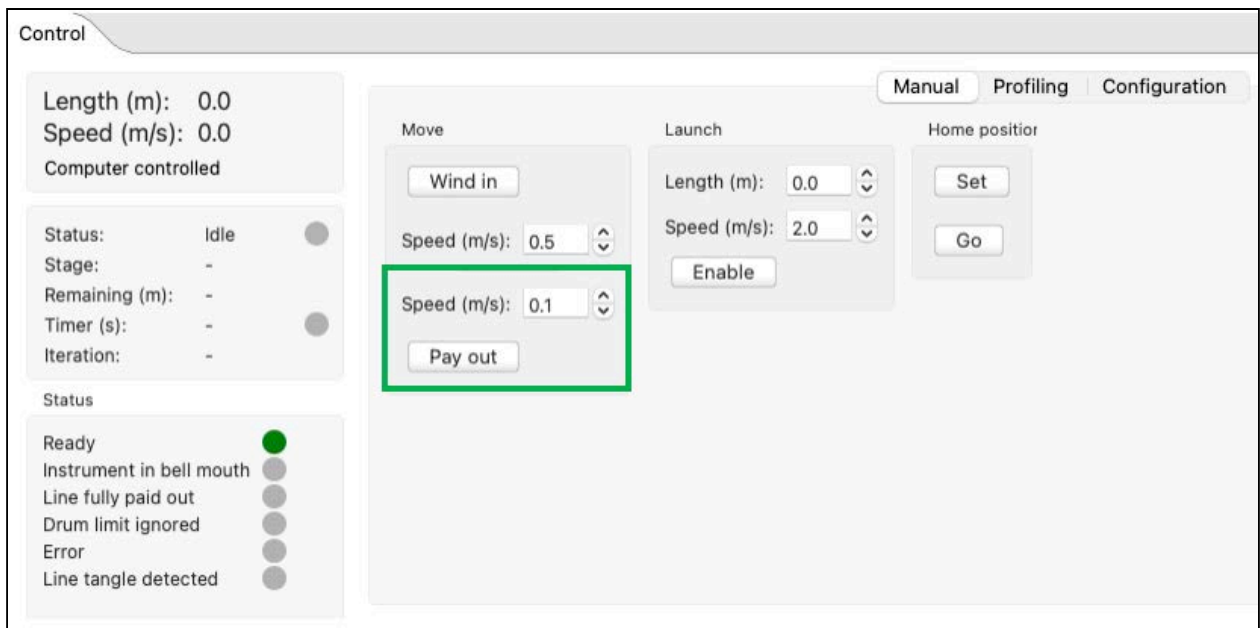

9. Turn the power off again.
10. Place the sheave unit horizontally to facilitate access.
11. Unscrew the metal wall on the sheave unit covering the two line tensioner rollers.

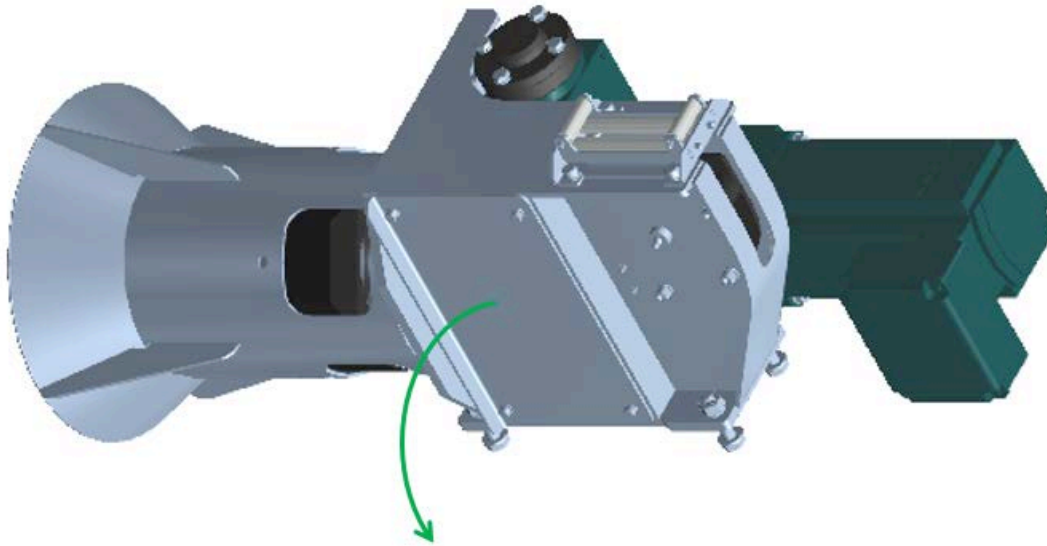

12. Insert the line through the fairlead on the top of the sheave unit and over the wheel down.

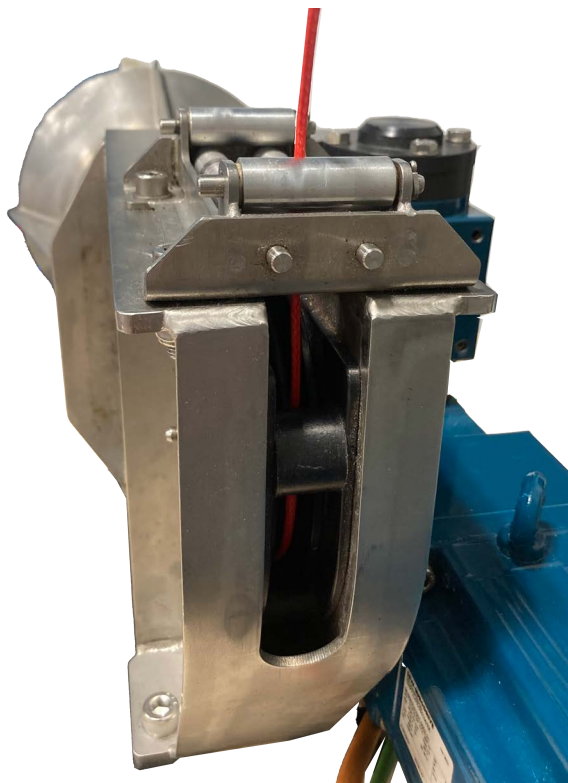



13. Pull the line in front of the line tensioner rollers and out of the bell mouth. Hold the end of the line with your hand for the following step.

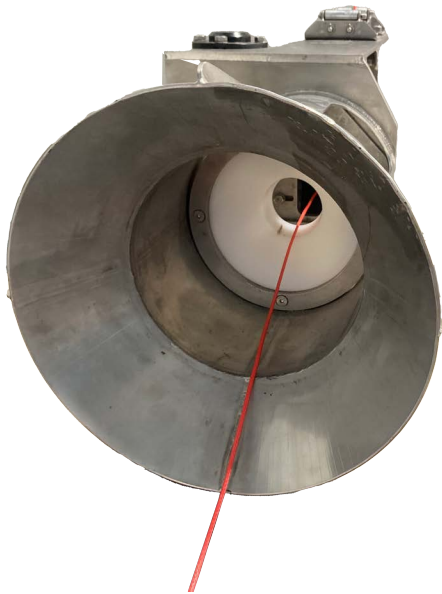

**⚠** The two tensioner rollers are sitting very snug, so leave the line outside the point where they touch. Once the winch starts moving, the line will be drawn in between the rollers.

14. Holding the end of the line, pull on it and confirm that the line is now between the rollers.



**Line outside the rollers**



**Line drawn in**



15. Disconnect the insertion tool from the line by removing the tape.

**⚠ Do not cut the line to remove the insertion tool. You will need the loop at the end of the line to attach your instrument.**

16. Secure your instrument at the end of the line using the soft shackle provided.

17. Manually add some slack to the line between the sheave and the drum.

18. Put the panel back on the sheave and screw it in.

19. Place the cover back on the drum.

20. Turn the power on and push **RESET** on the handheld remote control.

21. On Ruskin, reconnect to the winch.

22. Using the **Wind in** and **Pay out** buttons, bring the instrument to the bell mouth.

23. Under **Home position**, click **Set**. This will be the zero position for your instrument.

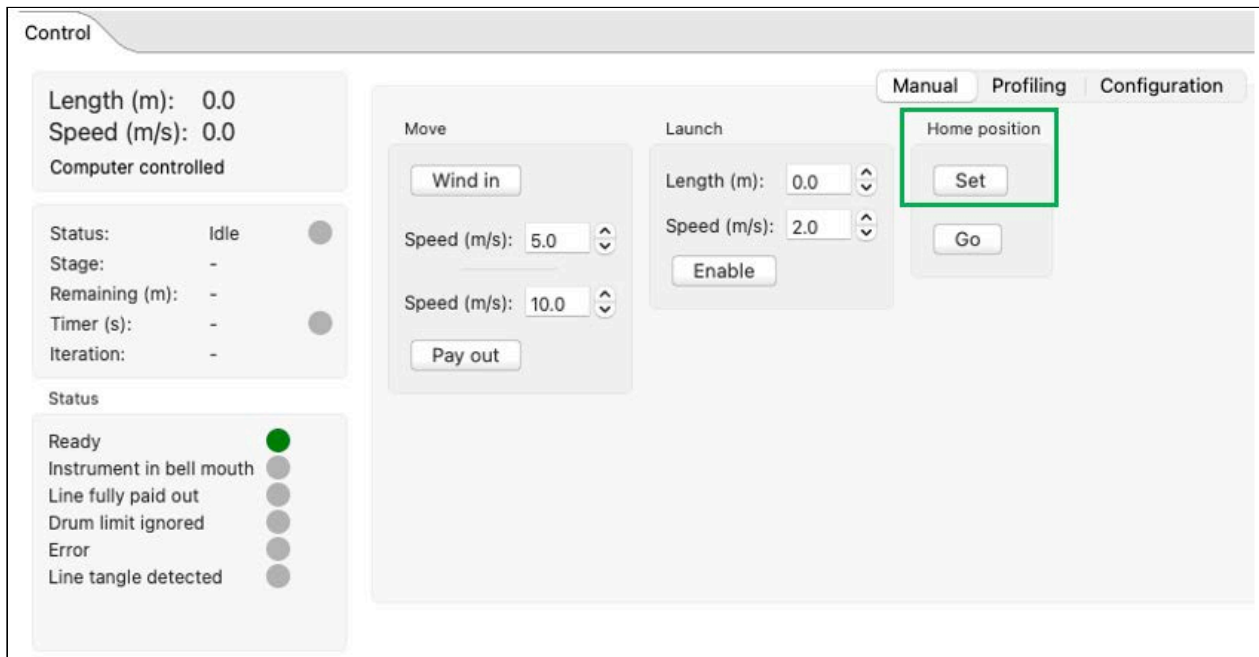

## 5.7 Mounting the sheave unit

After feeding the line from the drum unit to the sheave, proceed with mounting the sheave unit.

**i** With some A-frames, you may be able to mount and secure the sheave to the A-frame first, then feed the line to it.

### Steps

1. Unplug the sheave unit power cable from the control cabinet.
2. Ensure that the line has enough slack for you to hold the end coming out of the bell mouth while the sheave is raised up to the A-frame or boom.
3. Mount the sheave unit above the water on an A-frame or a boom, in line with the drum unit, and secure the cables.



4. Plug the power cable back in to the control cabinet.

## 6 Configuring the RBRglissando

The **Configuration** tab has two parts: **Information** and **Settings**.

The screenshot shows the 'Control' interface for the RBRglissando. It features three tabs: 'Manual', 'Profiling', and 'Configuration'. The 'Configuration' tab is selected. The interface is divided into two main sections: 'Information' and 'Settings'. The 'Information' section displays system parameters: IP address (192.168.100.255), Port (2000), Last update (2023-08-17T13:08:21.858Z), Type (RBRglissando), Version (42), Protocol (2), and Software (45). The 'Settings' section includes 'Handheld remote speed' with 'Wind in (m/s)' and 'Pay out (m/s)' both set to 0.6. Below this is a section for 'Respooling drum options' with 'Save' and 'Reset' buttons. On the left side, there are status indicators: 'Length (m): 0.0', 'Speed (m/s): 0.0', 'Computer controlled', 'Status: Idle', 'Stage: -', 'Remaining (m): -', 'Timer (s): -', 'Iteration: -', and a 'Status' list with indicators for 'Ready' (green), 'Instrument in bell mouth', 'Line fully paid out', 'Drum limit ignored', 'Error', and 'Line tangle detected'.

**Information** lists several system parameters, and these values are not editable.

**Settings** allows for adjusting the manual speeds for the handheld remote control unit, as well as for setting the respooling parameters.

Generally, you do not need to change any parameters under **Settings**. Your RBR*glissando* ships with the line already spooled on the drum, all respooling drum options set up, and manual speeds configured.

 Changing these settings may render the winch inoperable. Proceed with caution.

If undertaking any changes, refer to applicable [Maintenance](#) sections for instructions.

## 7 Using the Wi-Fi module

RBR instruments equipped with a Wi-Fi module have the **WI-FI READY** icon on the end-cap. It is enabled at the time of purchase.

Use the Wi-Fi module to download the realtime data and process them while still at sea. There is no need to open the instrument or even recover it, and no need to be close to the shore as your instrument will be the router point.

When activated, the instrument will create its own SSID network which will appear under Wi-Fi networks on your device. Your device will switch to this network and connect to the instrument. If set to **Auto-download**, Ruskin will start downloading the data.

There are two ways to activate the Wi-Fi on RBR instruments: twist activation and pressure switch.

### Twist activation

Activate the Wi-Fi by twisting the end-cap in either direction. The Wi-Fi will stay on for 180 seconds, waiting for you to connect. The instrument needs to be close enough for you to reach it and turn it on.



**⚠** The Wi-Fi is disabled after 180 seconds of inactivity. Twist the end-cap to **RUN** or **PAUSE** to re-activate the Wi-Fi.

**⚠** Twisting the end-cap to the **RUN** or **PAUSE** position will activate the Wi-Fi. However, twisting to the **PAUSE** position will also pause the instrument, as described above. Twist the end-cap back to **RUN** before continuing with deploying your instrument.

## Pressure switch

When your instrument goes underwater, the Wi-Fi will go off at the depth of 1-2m because the signal cannot get through. However, even if the instrument stays on the surface, the Wi-Fi will go off after three minutes (180s) of inactivity. Thus, there will be no connection to the instrument while it is in the downcast phase.

During the upcast, the instrument will detect the drop in pressure and automatically switch on the Wi-Fi at about 2m below the surface. The Wi-Fi will stay on for 180s. If your laptop is within reach during this time, Ruskin will reconnect to the instrument and start downloading the dataset.

**⚠** This feature does not apply to shallow deployments (2m or less).

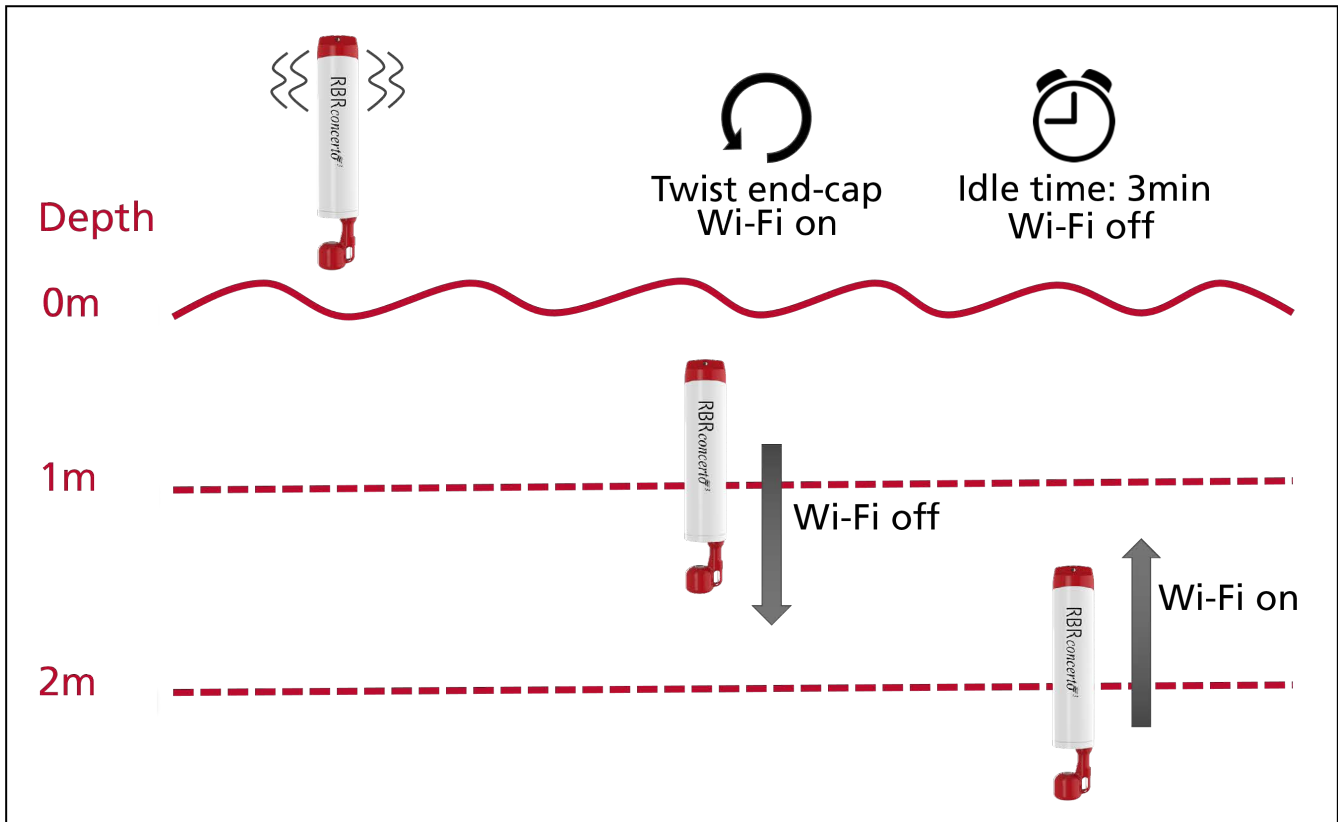

**⚠** The nominal Wi-Fi range is 30m for instruments in plastic housing and 10m for titanium, but it may be shorter in real life due to challenging physical environments.

**⚠** If the Wi-Fi connection is lost in the middle of the download, Ruskin will continue from where it left off next time it detects the instrument again, appending the original RSK file.

## 8 Setting up an instrument

If your *RBRglissando* is already on Ruskin, you can associate your instrument with the winch before the deployment. See [Connecting to Ruskin](#) on how to connect your winch.

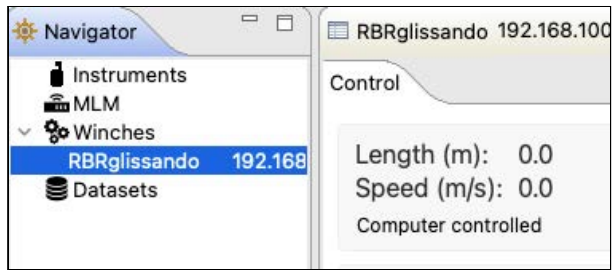

**i** An instrument associated with the *RBRglissando* will have three minutes of idle time before its **Wi-Fi** turns off, instead of only one minute.

### Steps to associate your instrument

1. Unscrew the battery end-cap and connect your instrument to Ruskin via a USB port.
2. When the instrument appears on Ruskin, verify all settings.

**i** RBR instruments ship with the fastest sampling **Rate** selected, the **Wi-Fi** enabled, and **Gating** set to **Twist activation**.

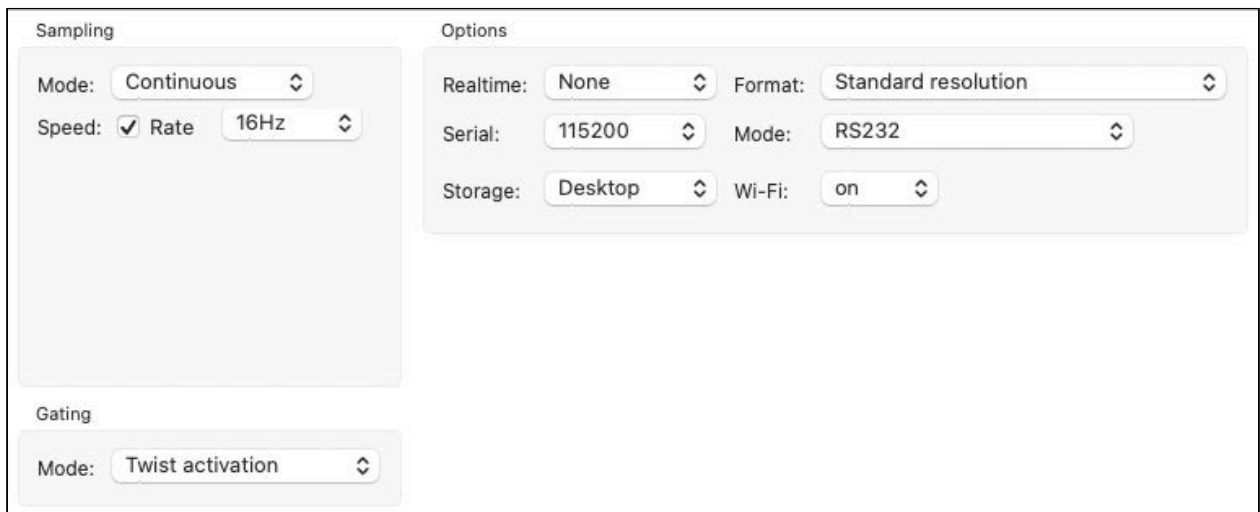

3. Ensure that the **Wi-Fi** option is enabled. If not, go to **Options > Wi-Fi** and select "**on**" from the dropdown menu

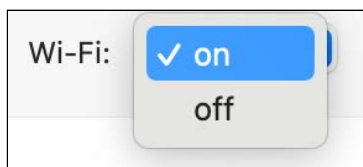

4. Ensure that **Gating** is set to **Twist activation**. If not, go to **Gating > Mode** and select "**Twist activation**" from the dropdown menu.

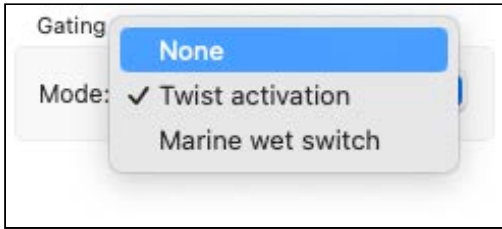

5. Confirm that Ruskin can now see both the instrument and the RBRglissando.
6. Right-click on your instrument and select **Associate with winch** from the dropdown menu.

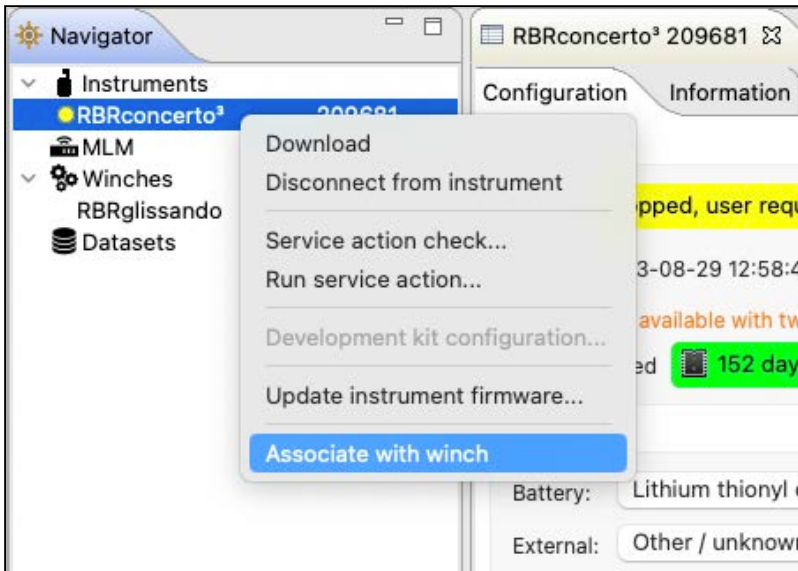

The instrument will move down to appear under the RBRglissando.

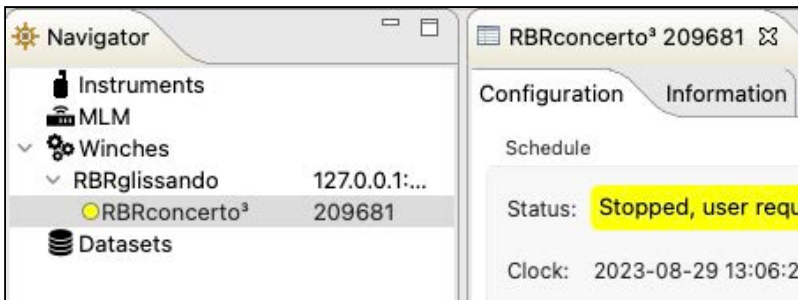



7. Click **Enable** in the **Configuration** tab to save all these settings to the instrument.

The screenshot shows the 'Configuration' tab for an instrument. The left sidebar lists 'Instruments' with 'RBRconcerto<sup>3</sup>' selected. The main panel shows the 'Schedule' section with 'Status: Stopped, user request' (yellow bar), 'Clock: 2023-09-15 12:32:55-05:00', and 'End: Gated' with a battery icon and '152 days' (green bar) and 'NA' (orange bar). The 'Power' section shows 'Battery: Lithium thionyl chloride' and 'External: Other / unknown'. The 'Memory used' is '<1%'. The 'Enable' button is highlighted with a red box. A green message at the bottom says 'Schedule valid - memory and battery estimates are based on active run time'.

The yellow circle next to your instrument will turn cyan and the **Status** will update to **Logging paused**. The **Enable** button will become **Stop**.

The screenshot shows the 'Configuration' tab for an instrument. The left sidebar lists 'Instruments' with 'RBRconcerto<sup>3</sup>' selected. The main panel shows the 'Schedule' section with 'Status: Logging paused' (cyan bar), 'Clock: 2023-09-15 13:12:03-05:00', and 'End: Gated' with a battery icon and '152 days' (green bar) and 'NA' (orange bar). The 'Power' section shows 'Battery: Lithium thionyl chloride' and 'External: Other / unknown'. The 'Memory used' is '<1%'. The 'Stop' button is visible.

Sampling will only start when you twist the end-cap to **RUN** (see below).



8. Disconnect the USB cable and return the battery end-cap on the instrument.

 The instrument will disappear from Ruskin. This is normal; proceed to the next step.

9. Twist the battery end-cap on the instrument to either direction to activate the Wi-Fi. The RBR*glissando* will see the instrument and automatically connect to it.

 The instrument will re-appear on Ruskin, connected to the winch.  
If you have twisted it to **RUN**, the instrument will also start logging. Twist the end-cap to **PAUSE** if you are not ready to start your deployment.

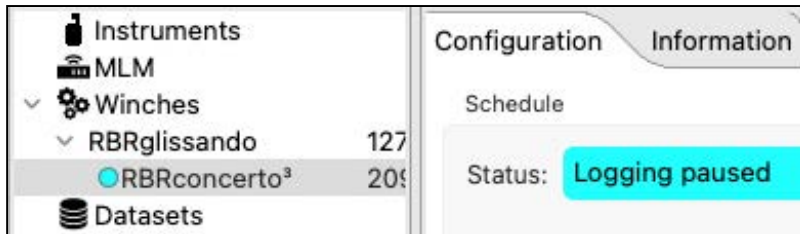

10. Secure your instrument at the end of the winch line using the soft shackle provided.

### Steps to start the deployment

1. Check the colour of the circle next to your instrument.

If it is green, your deployment has already started.

If it is cyan or yellow, go to the next step.

2. Twist the battery end-cap to **RUN**.



The cyan circle next to your instrument will turn green and the **Status** will update to **Logging in progress**.

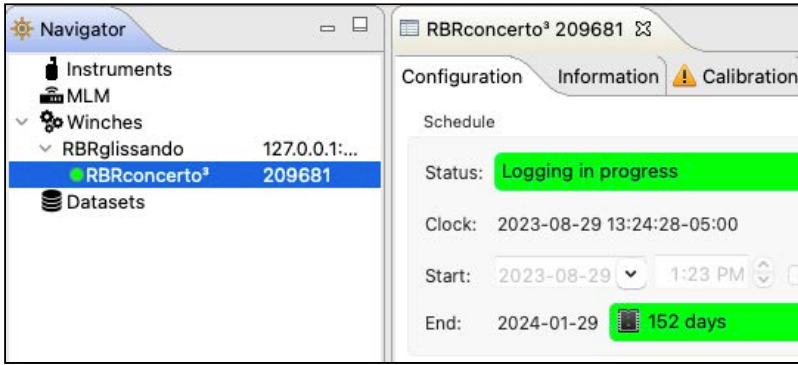

### Steps at the end of the deployment

1. When the deployment is complete, stop logging by clicking **Stop** in the **Configuration** tab for your instrument.

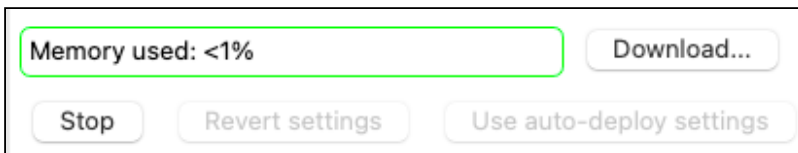

The green circle next to your instrument will turn yellow and the **Status** will update to **Stopped, user request**.

2. Right-click on the instrument and select **Remove from winch** to dis-associate it.

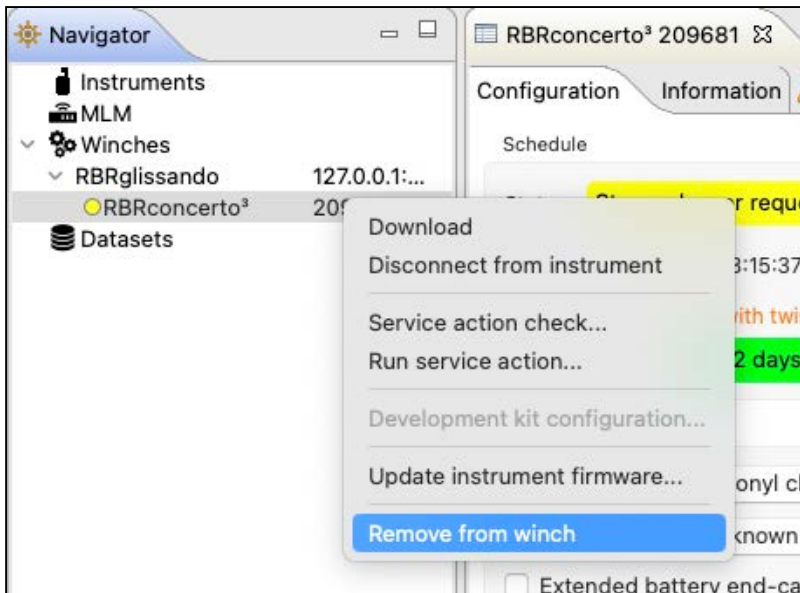

The instrument will move up to appear under **Instruments**.

**i** Ruskin will remember a previous association and re-associate the instrument with the *RBRglissando* upon reconnection.

## 9 Setting up automated profiling

Go to the **Profiling** tab to set up automated profiling schedules for your RBRglissando.

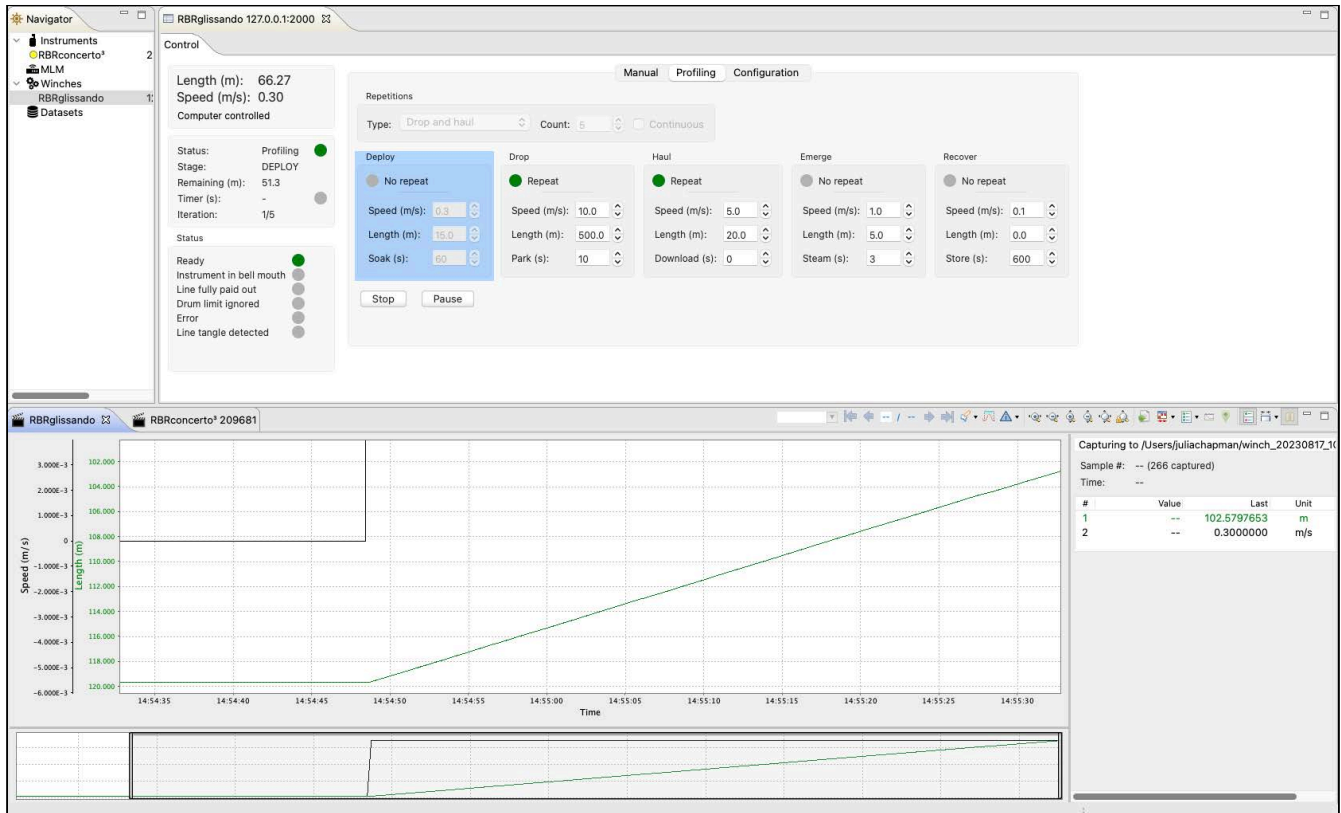

The **winch cycle** consists of five stages:

- **Deploy** - lower down your instrument from the bell mouth to the water surface
- **Drop** - pay out the line at a high speed casting your instrument to the maximum deployment depth
- **Haul** - wind in the line bringing your instrument back to the surface
- **Emerge** - slowly pull your instrument out of the water
- **Recover** - return your instrument to the bell mouth

You can also select the number of repetitions for these stages, and launch or stop the cycle.

### 9.1 Home position

The **Home position** of the winch cycle is in the bell mouth. The absolute position of the instrument at any time is estimated with respect to the **Home position**.

Typically, you will set it when first **feeding the line to the sheave unit**. If any adjustments are necessary, follow the steps below.

## Steps

1. Go to the **Manual** tab.

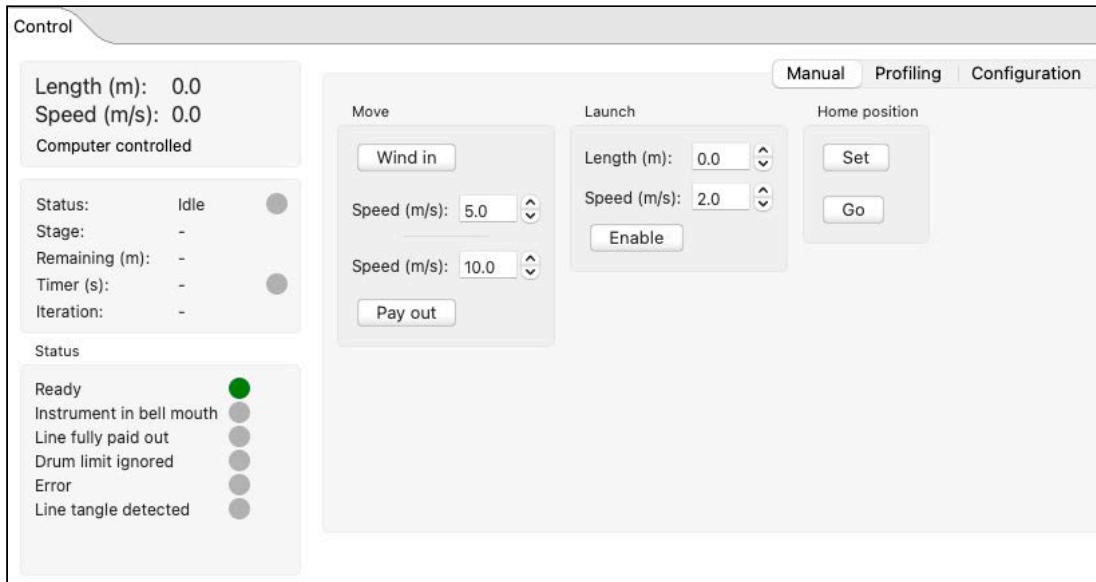

2. Under **Move**, use the **Wind in** button to bring the instrument to the bell mouth.

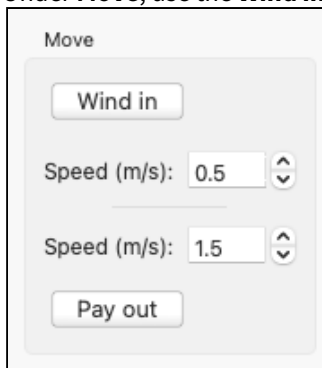

3. Under **Home position**, click **Set**. This will be the zero position for your instrument.

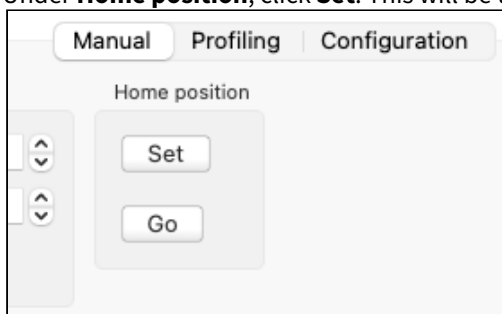

✓ If the winch cycle stops before the instrument is recovered, click **Go** under **Home position**, and the RBR*glissando* will return it to the bell mouth.

## 9.2 Winch cycle

The winch cycle consists of five stages: **Deploy**, **Drop**, **Haul**, **Emerge**, and **Recover**. For each stage, you can set the line speed in m/s, the instrument position in meters, and the pause time in seconds.

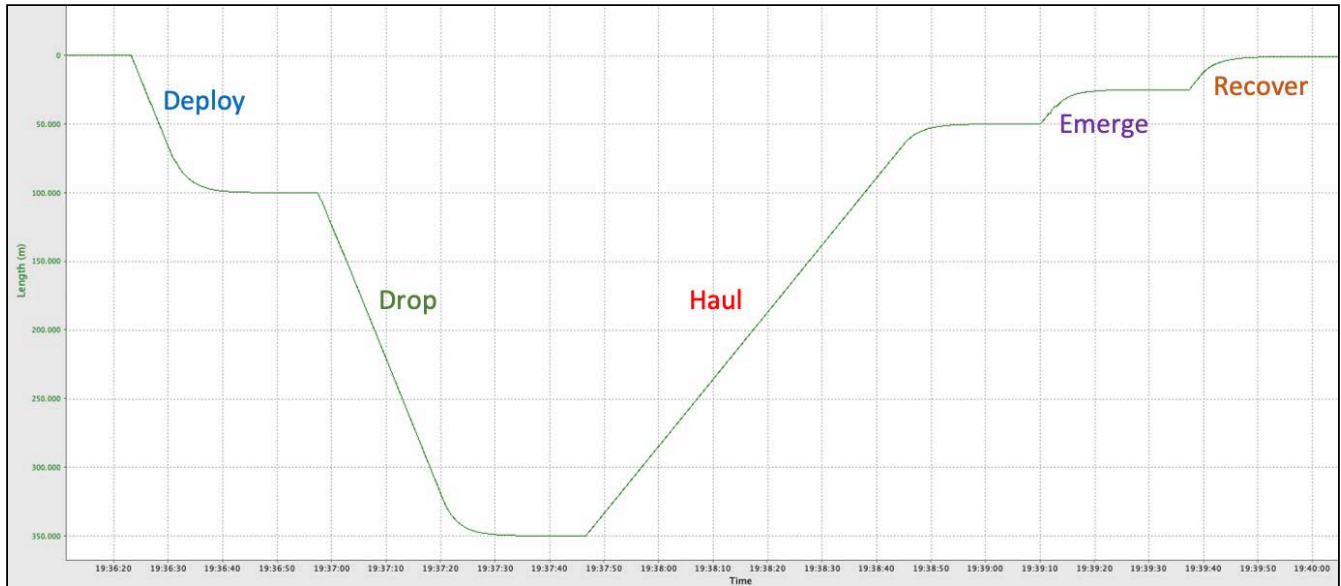

### Deploy

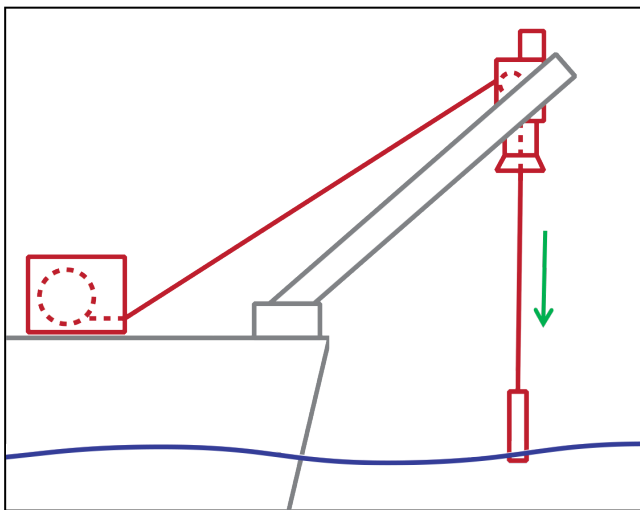

Slowly lower down your instrument to the surface and soak it there for at least a minute to allow the CTD to equilibrate to water temperature.

## Drop and Haul

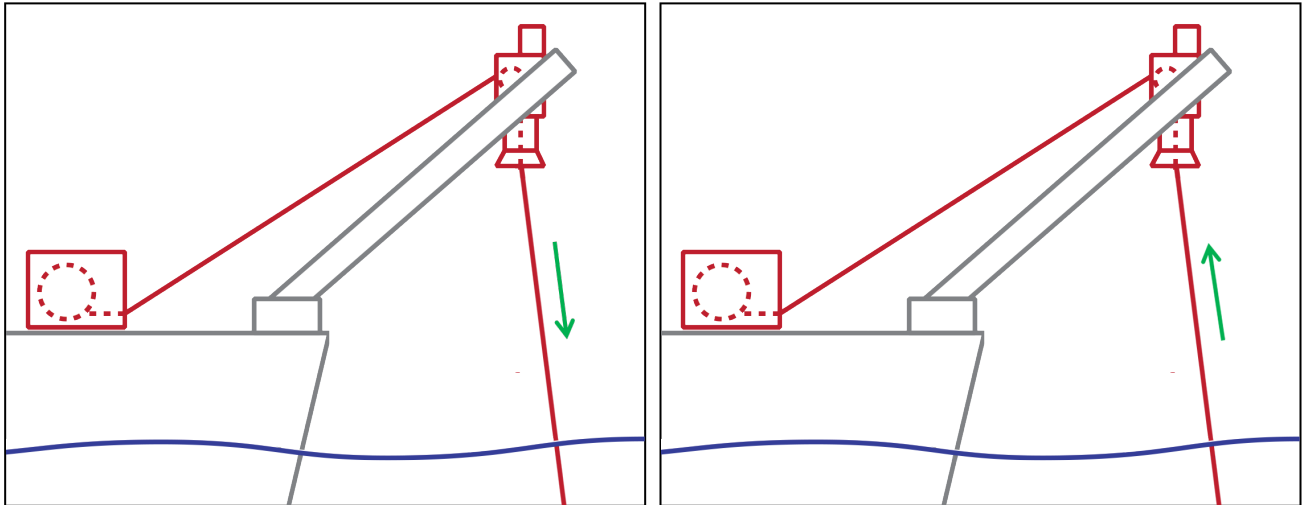

These two stages constitute one profile, the downcast and the upcast. Drop the instrument at a high speed and then haul it up to the surface. **Drop** and **Haul** are typically repeated several times.

## Emerge and Recover

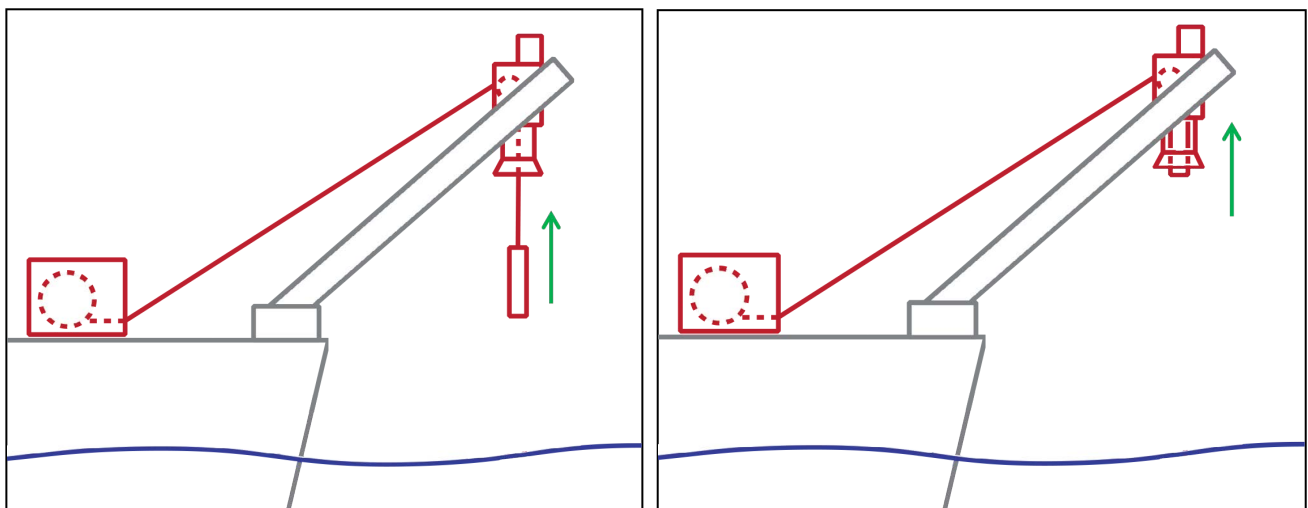

At the end of the last upcast, slowly pull the instrument out of the water. Then, at an even slower speed, return the instrument to the bell mouth.

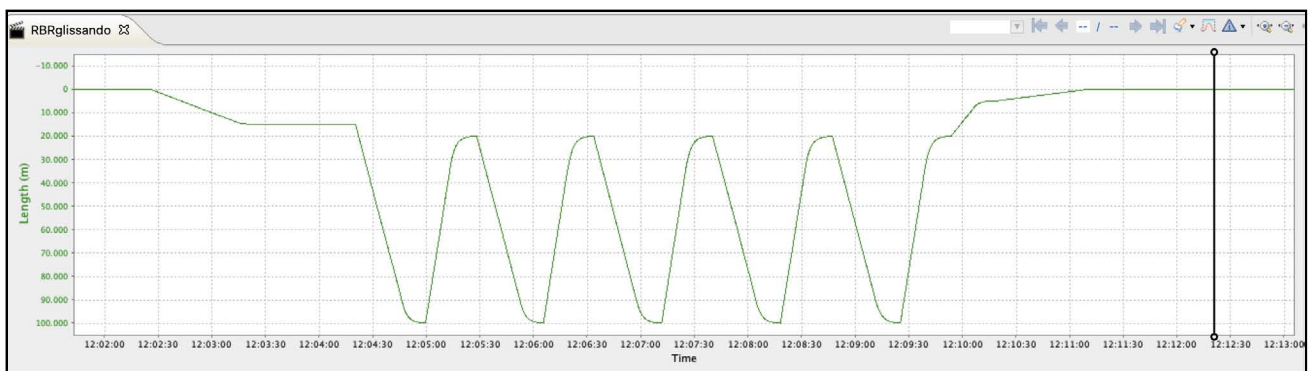

**i** For each stage, **Length (m)** indicates the absolute position of the instrument with respect to the **Home position**.

Deploy	Drop	Haul	Emerge	Recover
<input checked="" type="radio"/> Repeat	<input checked="" type="radio"/> Repeat	<input checked="" type="radio"/> Repeat	<input checked="" type="radio"/> Repeat	<input checked="" type="radio"/> Repeat
Speed (m/s): 2.0	Speed (m/s): 10.0	Speed (m/s): 2.0	Speed (m/s): 2.0	Speed (m/s): 2.0
Length (m): 3.0	Length (m): 100.0	Length (m): 20.0	Length (m): 3.0	Length (m): 0.0
Soak (s): 10	Park (s): 10	Download (s): 0	Steam (s): 3	Store (s): 600

Open the **Type** dropdown menu and select from **None**, **Drop and haul**, **Deploy and steam**, and **Full**. These options indicate which stages within the cycle must be repeated.

Repetitions

Type: **None** (dropdown menu open showing: None, Drop and haul, Deploy and steam, Full) Count: 0  Continuous

Deploy:  No repeat      Haul:  No repeat

After selecting an option, use **Count** to set the number of repetitions for the selected cycle, or opt for **Continuous** to repeat the cycle indefinitely.

Adjust the speeds, lengths, and times for each stage as required.

Click **Enable** to start.

Repetitions

Type: **Drop and haul** Count: 3  Continuous

Deploy	Drop	Haul
<input type="radio"/> No repeat	<input checked="" type="radio"/> Repeat	<input checked="" type="radio"/> Repeat
Speed (m/s): 1.0	Speed (m/s): 10.0	Speed (m/s):
Length (m): 3.0	Length (m): 125.0	Length (m):
Soak (s): 10	Park (s): 10	Download (s):

After the cycle starts, **Enable** will change to **Stop** and the **Pause** button will become active.



Pause the winch cycle at any time by clicking **Pause**. The button will then change to **Resume**.



Click **Resume** to continue with the cycle from where it was paused. For example, if it was in the middle of the **Drop** stage, it will continue to drop the instrument until it reaches the required length.

Click **Stop** to terminate the cycle. The button will change back to **Enable**. If you click **Enable** now, the winch will first return the instrument to its **Deploy** position (which is **Length(m): 3.0** in the example above) and then proceed with **Drop** and all the subsequent stages and repetitions.

On the left, Ruskin will display the current instrument position and line speed, as well as the status, stage, line length remaining to pay out or wind in on that moment, time left when the cycle is on pause, and the current iteration.

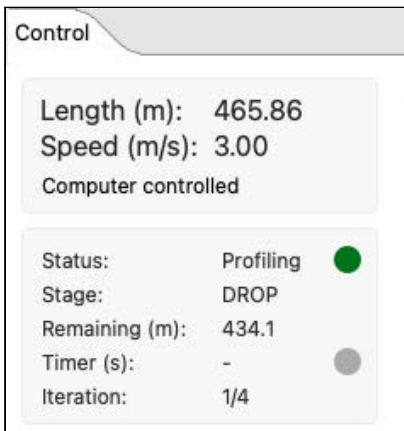

See [Example of automated profiling](#) for guidance on how to select automated profiling parameters.



## 9.3 Example of automated profiling

The profiling parameters below reflect a typical deployment setup for our popular standard instrument, the RBR*concerto*<sup>3</sup> C.T.D, with several downcasts and upcasts. Follow these steps when setting up your deployment, or adjust the values as needed.

In this example, we use a 500m line.

Select a **Drop and haul** type, then enter **Count** (the number of repetitions). **Count** = 4 means there will be five (5) iterations of the **Drop** and **Haul** stages, while **Deploy**, **Emerge**, and **Recover** will be run once each.

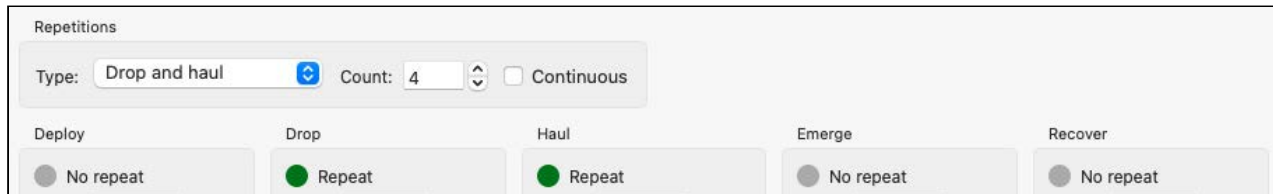

Repetitions

Type: Drop and haul Count: 4 Continuous

Deploy: No repeat

Drop: Repeat

Haul: Repeat

Emerge: No repeat

Recover: No repeat

Set up the RBR*glissando* parameters for each stage and click **Enable**.

- **Deploy**

Slowly lower your instrument at 0.3m/s. Pay out 15m of the line so that the instrument is just below the water surface. Usually, the best initial position would be the height of the boat plus 3-5 meters. Soak the instrument there for at least a minute to allow the CTD to equilibrate to water temperature.

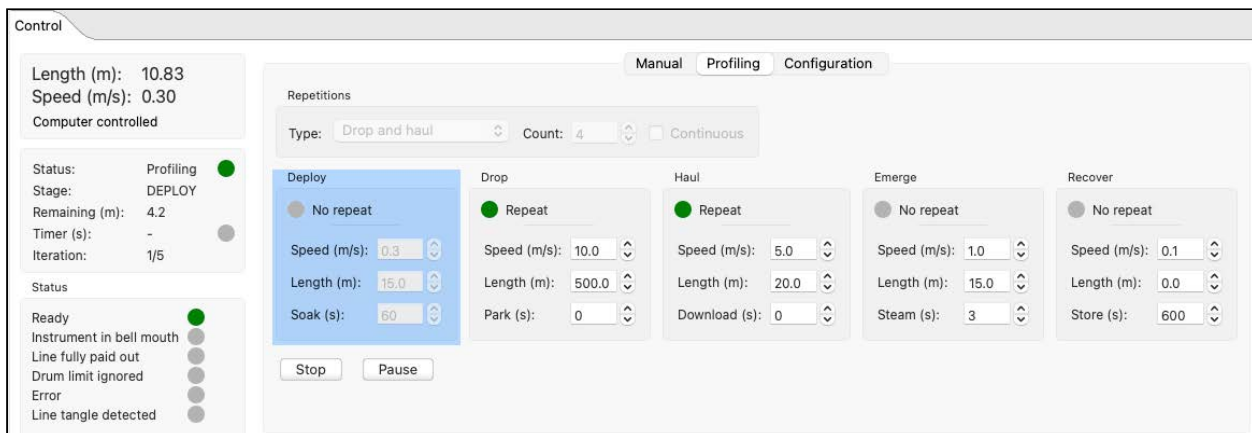

Control

Length (m): 10.83  
Speed (m/s): 0.30  
Computer controlled

Status: Profiling (green)  
Stage: DEPLOY  
Remaining (m): 4.2  
Timer (s): -  
Iteration: 1/5

Ready (green)  
Instrument in bell mouth (grey)  
Line fully paid out (grey)  
Drum limit ignored (grey)  
Error (grey)  
Line tangle detected (grey)

Manual Profiling Configuration

Repetitions

Type: Drop and haul Count: 4 Continuous

Deploy: No repeat  
Speed (m/s): 0.3  
Length (m): 15.0  
Soak (s): 60

Drop: Repeat  
Speed (m/s): 10.0  
Length (m): 500.0  
Park (s): 0

Haul: Repeat  
Speed (m/s): 5.0  
Length (m): 20.0  
Download (s): 0

Emerge: No repeat  
Speed (m/s): 1.0  
Length (m): 15.0  
Steam (s): 3

Recover: No repeat  
Speed (m/s): 0.1  
Length (m): 0.0  
Store (s): 600

Stop Pause

- **Drop**

Drop your instrument into the water at a high speed, 10m/s, paying out the line all the way to the desired position of 500m. This means that the winch will spool out 485m more, adding this length to the 15m where the instrument was at the end of the **Deploy** stage.

When the **Drop** speed is higher than the speed of the moving boat, the instrument goes down almost vertically; otherwise, you may need to take into account the angle when estimating the profile depth.

✔ Set the **Park** time to zero to move directly to the next stage.

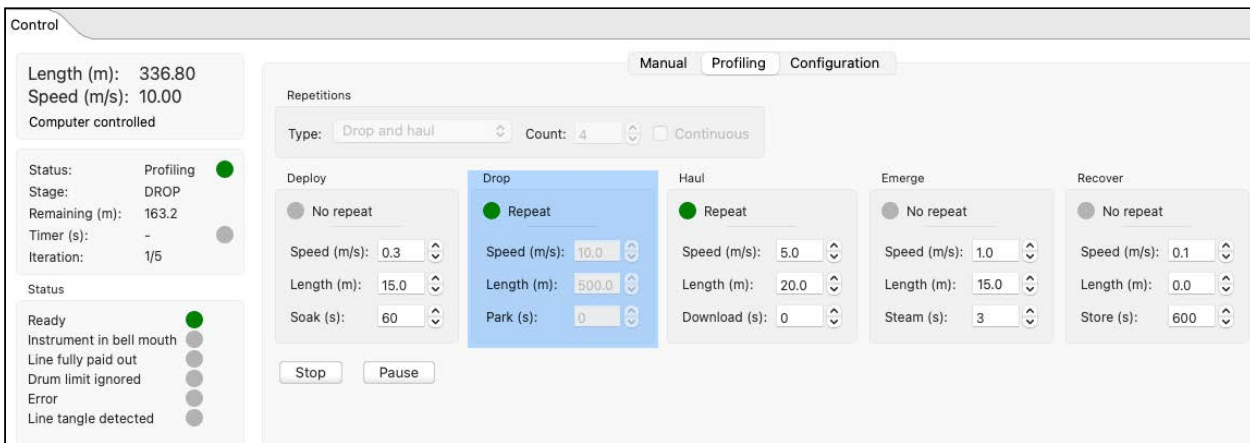

- **Haul**

Quickly haul your instrument up at 5m/s, to 20m, which is approximately the **Deploy** position. It is often convenient to set up different positions for **Deploy** and **Haul** to visually distinguish between the stages during repetitions.

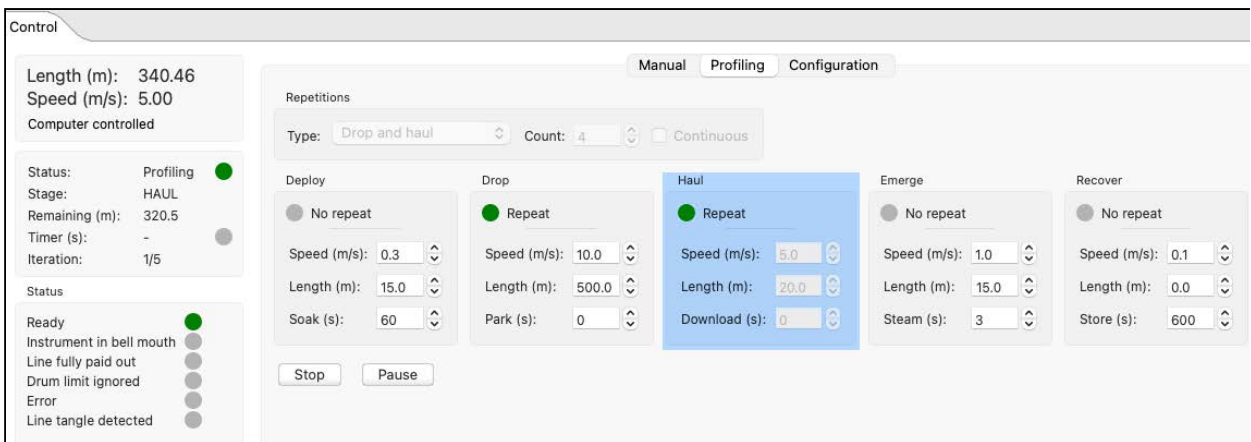

✔ Set the **Drag** time to zero to move directly to the next stage.

At this point the cycle will start its repetitions. It will go back to **Drop**, then to **Haul** again, four more times. This means the total number of iterations will be five. With **Park** and **Download** times set to zero, there will be no pause between stages. After completing the last iteration, the winch will move to **Emerge**.

- **Emerge**

Slowly (at 1m/s) pull the instrument up above the water. Winding five meters in will move the instrument from the 20m position to the 15m position, which is where it was at the end of the **Deploy** stage.



- **Recover**

Very slowly (at 0.1m/s) lift the instrument to the bell mouth until it safely stops. This corresponds to a zero position. The instrument will remain in the bell mouth for 600s to enable safe download.

The screenshot shows the 'Control' window with tabs for 'Manual', 'Profiling', and 'Configuration'. The 'Repetitions' section is set to 'Drop and haul' with a count of 5. The 'Deploy' stage is set to 'No repeat' with a speed of 0.3 m/s and a length of 15.0 m. The 'Drop' stage is set to 'Repeat' with a speed of 10.0 m/s and a length of 500.0 m. The 'Haul' stage is set to 'Repeat' with a speed of 5.0 m/s and a length of 20.0 m. The 'Emerge' stage is set to 'No repeat' with a speed of 1.0 m/s and a length of 15.0 m. The 'Recover' stage is highlighted in blue and set to 'No repeat' with a speed of 0.1 m/s and a store time of 600 s. On the left, status indicators show 'Profiling' is active, 'STORE' is the current stage, and 'Timer (s)' is 111. A 'Ready' status bar shows 'Instrument in bell mouth' as active.

⚠ Depending on your profiling parameters, you could automatically download the datasets after during **Haul**, **Emerge**, and **Recover** stages. Select such values of **Length (m)** and **Download (s)** which allow for the Wi-Fi signal to reach your laptop. Refer to [Automatic downloads](#) for details.

Monitor the winch operation in the **Plot window**. The speed of the winch and the line length will be displayed, along with any notifications and warnings which might take place.

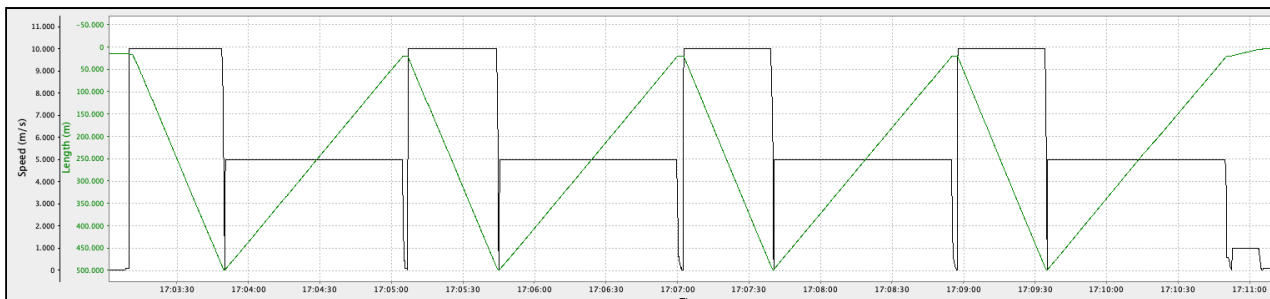

## 9.4 Automatic downloads

When your instrument is equipped with the Wi-Fi module, you can download the dataset after each profile, providing the Wi-Fi signal can reach Ruskin. To this end, you need to enable automatic downloads and adjust the profiling parameters.

**i** RBR instruments with a built-in Wi-Fi module have the **WI-FI READY** icon on the end-cap. The Wi-Fi module needs to be enabled at the time of purchase. Contact [RBR](#) if you have any question about this feature.

### 9.4.1 Setting up Ruskin to Auto-download

On Ruskin, open the **Instruments** menu on the top toolbar and go to **Automatic tasks > Auto-download**.

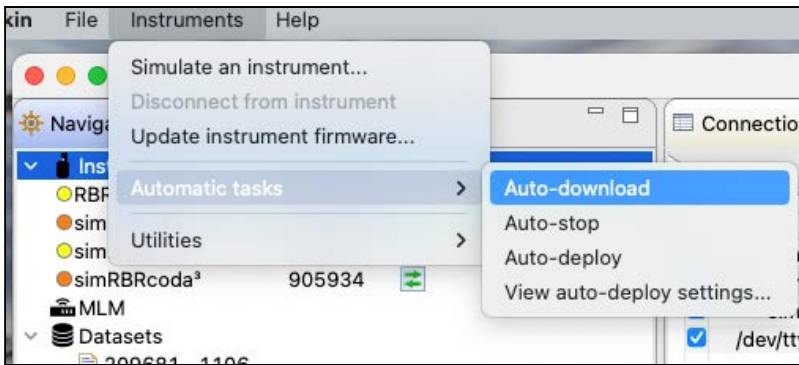

Alternatively, right-click **Instruments** in the **Navigator** window.

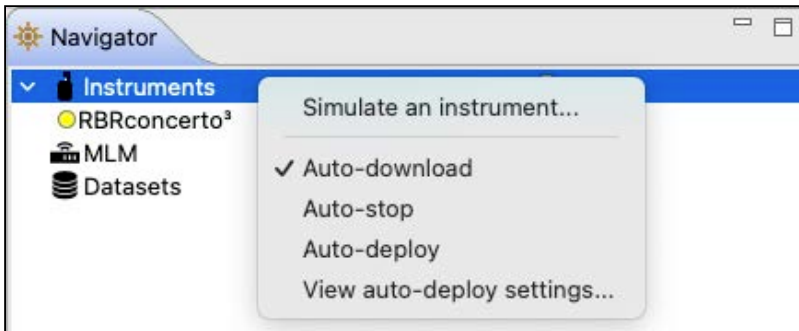

With the **Auto-download** feature enabled, Ruskin will automatically start a download process as soon as it detects an instrument. The downloaded dataset will be named following the standard naming convention, and saved in the default directory. See Ruskin User Guide: Standard Instruments<sup>3</sup>, sections 13 and 12.2 (available on the [RBR website](#) or on Ruskin, **Help > Documentation**).

## 9.4.2 Adjusting profiling parameters

Depending on the profiling parameters, you can use the **Haul**, **Emerge**, and **Recover** stages to download your dataset. Potentially, you could use the sum of the three pause times if the repetitions **Type** is set to **None**.

The instrument needs to be close enough for Ruskin to connect and pause long enough for the download to complete. When you haul the instrument out of the water, the Wi-Fi will turn on close to the surface and stay on for three minutes. If the instrument is still too far from the boat, make sure to bring it closer before the idle time runs out. After it connects to Ruskin, you need to maintain a close distance to continue downloading. If necessary, use the **Pause** button to allow the download to complete.

Here are some examples of setting up the instrument position and pause time to facilitate download.

### Example 1

Haul the instrument to the position of 10m, pause for 10s, then repeat the **Drop** and **Haul** stages four more times, downloading at the end of every **Haul** stage. After the fifth iteration, download for the last 10s of the **Haul** stage, for 3s at the end of the **Emerge** stage, and finally continue downloading while storing it in the bell mouth to ensure it is complete.

Haul	Emerge	Recover
<input checked="" type="radio"/> Repeat	<input type="radio"/> No repeat	<input type="radio"/> No repeat
Speed (m/s): 5.0	Speed (m/s): 1.0	Speed (m/s): 0.1
Length (m): 10.0	Length (m): 5.0	Length (m): 0.0
Download (s): 10	Steam (s): 3	Store (s): 600

### Example 2

Do not pause at the end of the **Haul** stage, going to the next iteration immediately. Steam for 10s at the end of the **Emerge** stage to ensure Ruskin detects the Wi-Fi signal from the instrument and then recover the instrument. Leave it in the bell mouth to allow for the download to complete.

Haul	Emerge	Recover
<input checked="" type="radio"/> Repeat	<input type="radio"/> No repeat	<input type="radio"/> No repeat
Speed (m/s): 5.0	Speed (m/s): 1.0	Speed (m/s): 0.1
Length (m): 20.0	Length (m): 5.0	Length (m): 0.0
Download (s): 0	Steam (s): 10	Store (s): 600

✔ When the instrument is out of the water and visible, you can stop the cycle and lift the instrument using [manual controls on Ruskin](#) or on the handheld remote.

✔ If the instrument is recovered but the Wi-Fi is off, use twist activation to turn it on.

## 9.5 Plot window

Monitor the winch operation in the **Plot** window.

By default, black indicates the speed of the winch and green, the line length, with current values reflected in the table on the right of the plot in real time.

Notifications and warnings appear at the bottom of the graph.

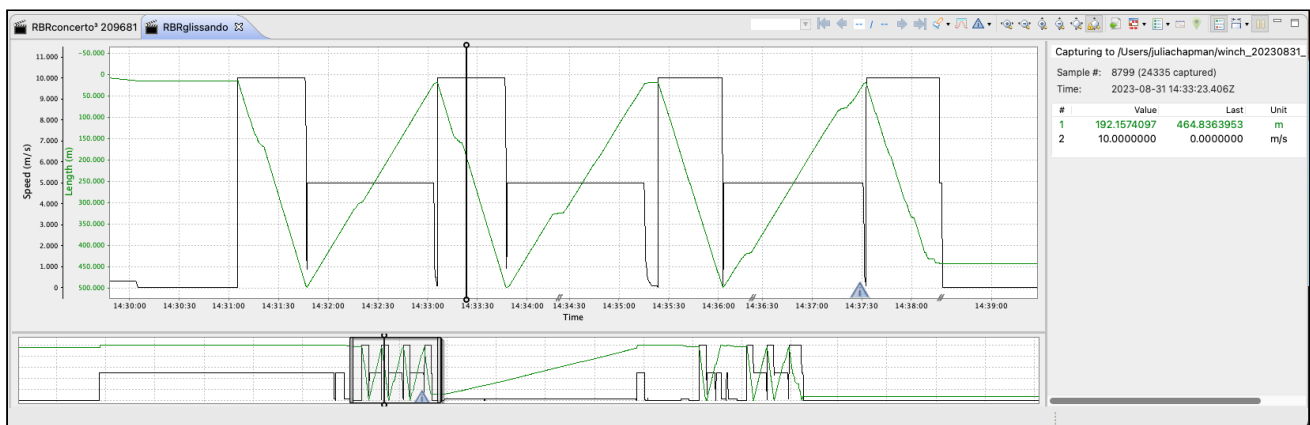



For details on navigating your **Plot** window, such as using annotations and zoom controls, see [Ruskin User Guide: Standard Instruments](#)<sup>3</sup>, sections 17.1 and 17.4.

## 10 Operating in manual mode on Ruskin

When you connect to the RBR*glissando*, the **Control** window defaults to the **Manual** tab, with two options: **Move** and **Launch**. These options allow you to wind in and pay out the line manually.

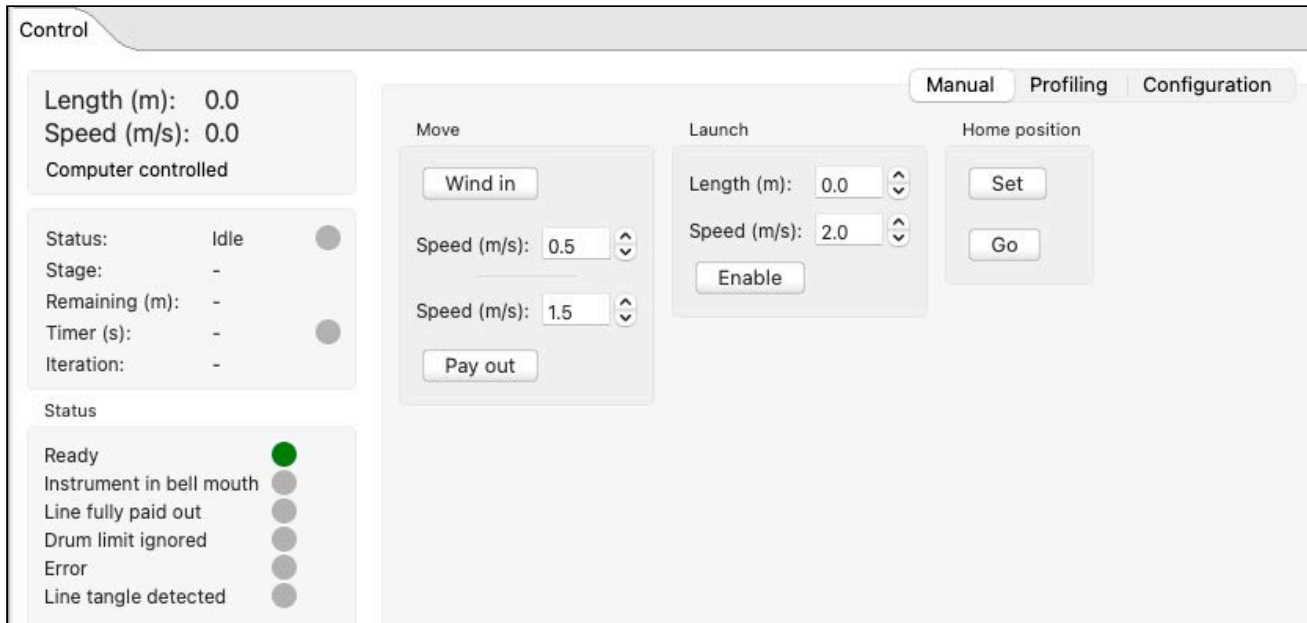
 if connection to Ruskin is lost, the winch will stop.



 Make sure that the line is tensioned during spooling.

### Move

Use this option to raise and lower your instrument manually.

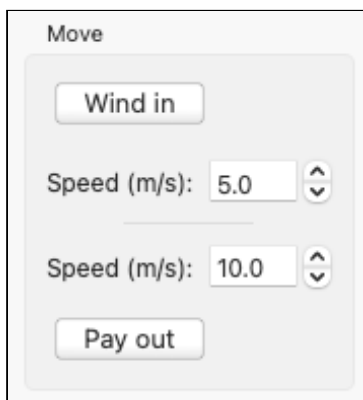



1. Set up the wind-in and pay-out speeds by clicking the up and down arrows or typing in the value.
2. Click **Wind in** to spool the line onto the drum.  
If you click once, the line will pay in bit by bit with each click.  
If you click and hold, the line will run in continuously until you let go of the button.
3. Click **Pay out** to unspool the the line into the water.  
If you click once, the line will pay out bit by bit with each click.  
If you click and hold, the line will run in continuously at the pay-out speed until it stops at the limit switch position.

**i** The maximum wind-in speed is 5m/s.  
The maximum pay-out speed is 10m/s.  
The minimum wind-in/pay-out speed is 0.1m/s.

### Launch

Use this option to drop your instrument to a desired position without using the automated profiling tools.

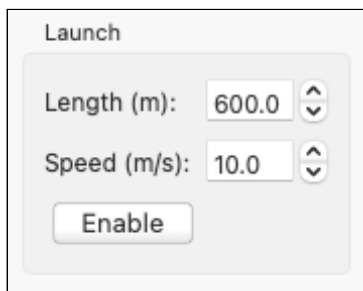

The screenshot shows a control panel titled "Launch". It contains two input fields: "Length (m):" with a value of "600.0" and "Speed (m/s):" with a value of "10.0". Both fields have up and down arrow buttons for adjustment. Below these fields is a button labeled "Enable".

1. Set up the line length necessary to unspool to reach your target launch position. Note that the launch position is limited by the line length on the drum.
2. Set up the launch speed.
3. Click **Enable**.

**i** The maximum launch speed is 10m/s.  
The minimum launch speed is 0.1m/s.

# 11 Manual controls on the winch

The RBR*glissando* is equipped with manual controls located on the cabinet control unit and on the handheld remote control unit. These include physical buttons and switches and can be used either when the computer is temporarily unavailable or in case of emergency.

⚠ Ensure you have access to the **Emergency stop** button at all times.

## 11.1 Cabinet control unit

The cabinet control unit of the RBR*glissando* has a panel to manually start and stop of the winch.

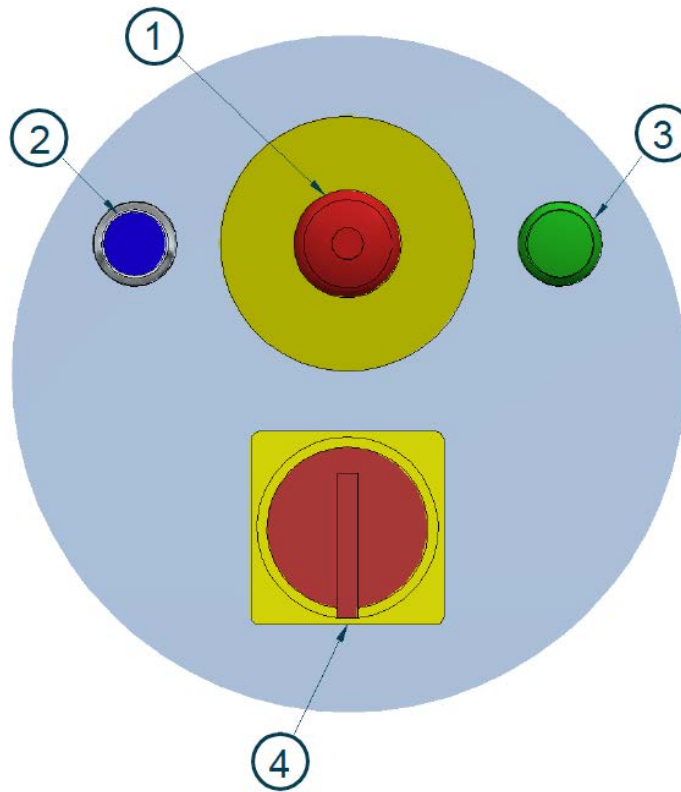

**Control cabinet panel**

1. **Emergency stop** - Emergency stop button; push to activate, twist to release
2. **Reset** - Emergency stop relay reset function, lights up when the emergency button is activated or when the power is first turned on
3. **Mains** - Indicates the system power state; lights up when the power is on
4. **Mains switch** - Powers the winch on or off

## 11.2 Handheld remote control unit

The RBR*glissando* is equipped with a handheld remote control unit, which allows for the manual operation of the winch.

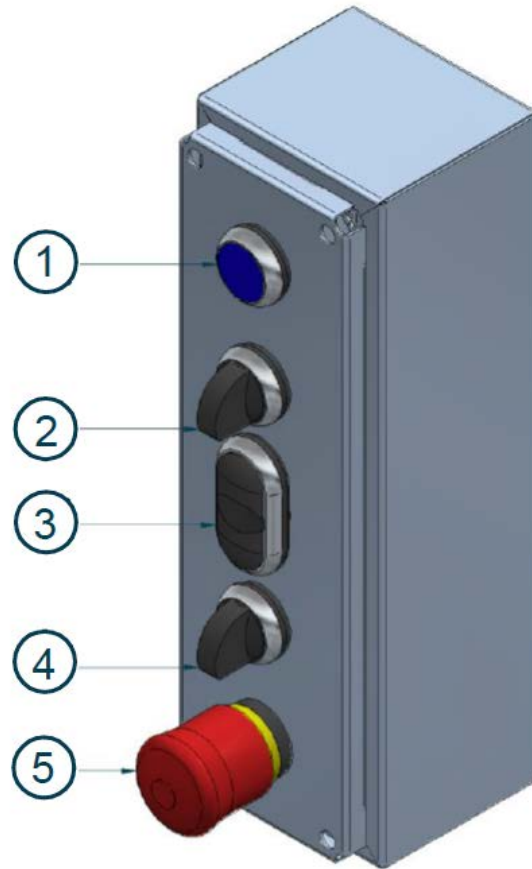

**Remote control panel**

1. **RESET** - Emergency stop relay reset function; lights up when the power is first turned on or the emergency button is activated
2. **LOCAL / REMOTE** - Switches between the manual (local) control and Ruskin (remote)
3. **UP / DOWN** - Raises or lowers the probe when in manual mode; this button contains a status indication light
4. **ON / OFF** - Powers the winch on or off; system power switch on control cabinet must be switched on
5. **Emergency stop** - Emergency stop button; push to activate, twist to release

Before using the handheld remote control unit, ensure the **LOCAL / REMOTE** switch (2) is in the **LOCAL** position. When it is, the white LED will be on continuously (no blinking).



Use the **UP / DOWN** buttons (3) to raise and lower your load slowly. The winch will move only when one of these buttons is pressed. Otherwise, the mechanical brake is activated and the winch stops.



## 12 Maintenance

### 12.1 Regular maintenance

Rinse the winch with fresh water at a regular interval to reduce wear.

Check the rolls on the sheave unit regularly to confirm the rubber is in good condition. Worn out rolls may cause the line slip and tangle. Replace the rolls if you discover signs of wear and tear. Contact RBR to order a new set of rolls at [support@rbr-global.com](mailto:support@rbr-global.com).

Check the electric motors of the drum unit and sheave unit every six months for oil level and colour. For guidance on oil replacement, scan the QR code on the side of the respective motor for access to the manufacturer's documentation.

### 12.2 Setting up manual speeds

The RBR*glissando* ships with the manual speeds configured. These are the speeds used by the handheld remote control unit and, generally, should not be changed.

 Exercise caution when changing default settings.

#### Steps

1. Connect the winch to Ruskin and open the **Config** tab.
2. Go to **Settings > Handheld remote speed**.

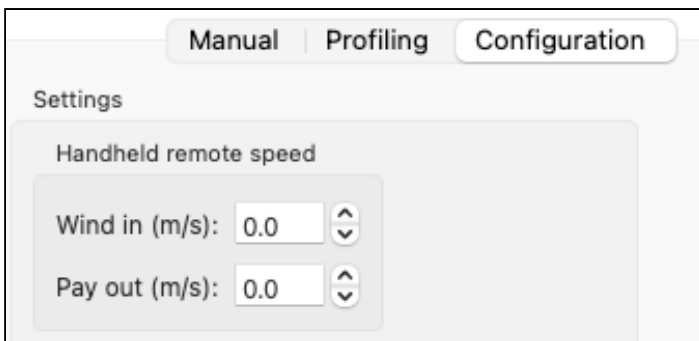

3. Change the **Wind in** and **Pay out** values using the up and down arrows or by typing in the required speed.

Now the remote control unit will use these speeds when the **UP / DOWN** button is pressed.

## 12.3 Removing the line from the drum

When replacing the line in the drum, you need to remove the old line first.

### Steps

1. Turn the power off using either the **Mains switch** on the control cabinet or the **ON /OFF** switch on the handheld remote control.
2. Remove the line from the sheave.
3. Turn the power on and push **RESET** on the handheld remote control.
4. On Ruskin, reconnect to the winch.
5. Go to the **Manual** tab and click **Pay out**. Unspool the entire length of the line until it stops.

**i** The default pay-out speed is 1.5m/s. Use the up and down arrows to change this setting, or type in the value.  
The maximum pay-out speed is 10m/s.

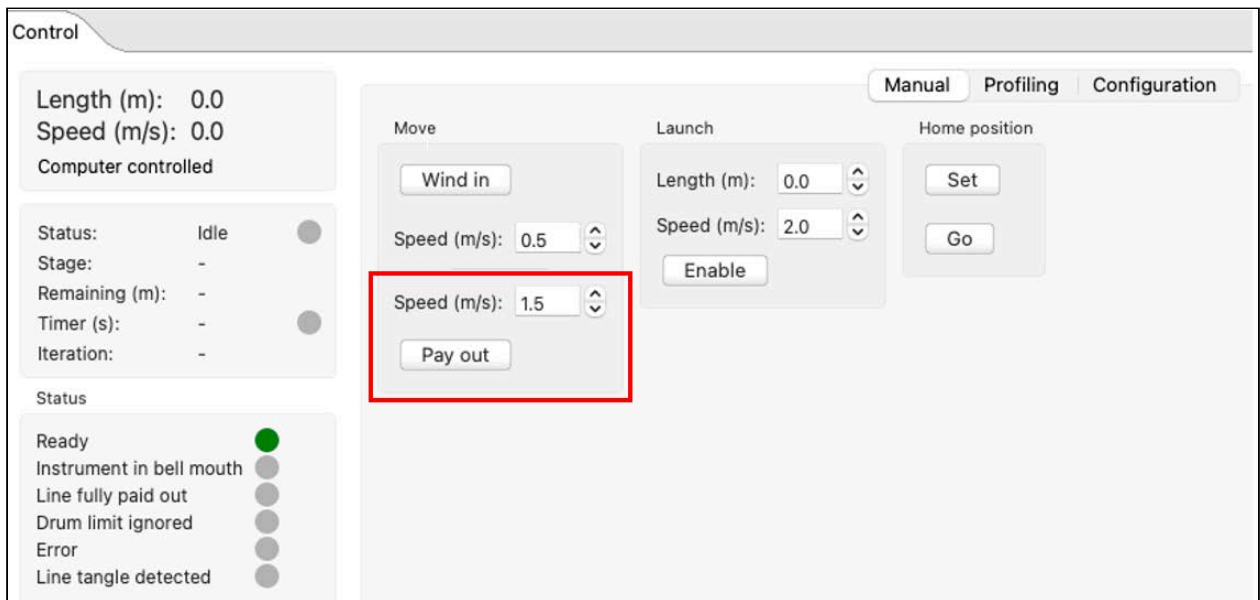

If you click once, the line will pay out bit by bit with each click.

If you click and hold, the line will run in continuously at the pay-out speed until it stops at the limit switch position.

The **Status** will indicate, "Line fully paid out".

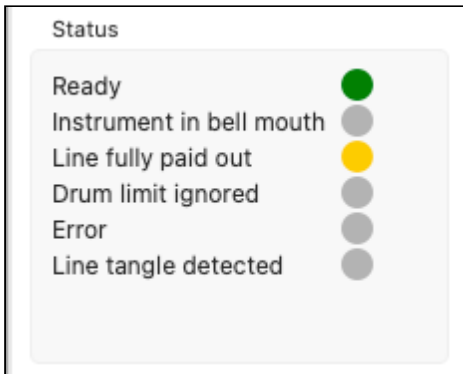

However, there will be about ten windings left on the drum.

6. Go to the **Configuration** tab, open **Respooling drum options** , and select the **Ignore drum limit** checkbox.

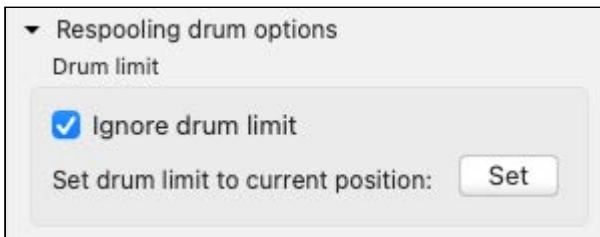

7. Return to the the **Manual** tab and click **Pay out** again.  
Slowly unspool the remaining line. Do not click and hold at this time.
8. Disconnect the line from the drum and pull it out completely.

## 12.4 Setting a drum limit

When respooling a new line on an empty drum, you need to set a new drum limit, that is, the maximum line position.

### Steps

1. Connect the winch to Ruskin and open the **Configuration** tab.
2. Open **Respooling drum options** under **Settings**.

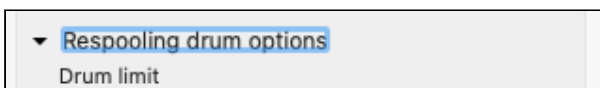



- Under **Line**, enter the line length and click **Save**.

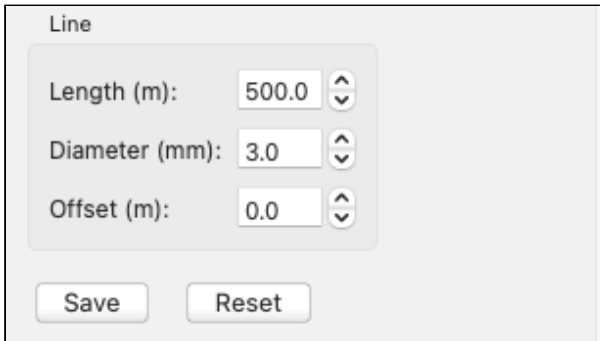

Line

Length (m): 500.0

Diameter (mm): 3.0

Offset (m): 0.0

Save Reset

**⚠** The RBR*glissando* uses the 3mm Dyneema line. The **Offset (m)** should be zero. Do not change the default values for **Diameter (mm)** and **Offset (m)** unless spooling a different gauge of the line.

- Turn the power off using either the **Mains switch** on the control cabinet or the **ON /OFF** switch on the handheld remote control.
- Feed the new line through the rollers to the drum and secure the end.
- Turn the power on and push **RESET** on the handheld remote control.
- On Ruskin, reconnect to the winch.
- Go to the **Manual** tab and set up the wind-in speed appropriate for your circumstances.
- Carefully spool ten windings of the line onto the drum.
- Go to the **Configuration** tab and open **Respooling drum options** under **Settings**.
- Under **Drum limit**, click **Set**.

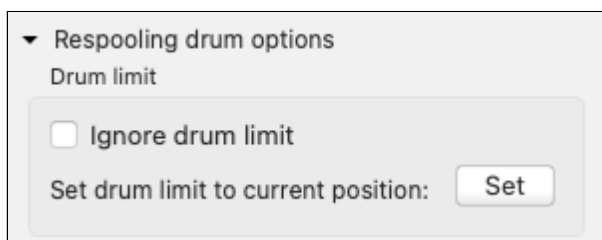

▼ Respooling drum options

Drum limit

Ignore drum limit

Set drum limit to current position: Set

## 12.5 Respooling the line onto the drum

After the [drum limit](#) and [line length](#) are set, respool the line.

**⚠** Make sure that the line is tensioned during spooling.

### Steps

1. Go to the **Manual** tab and click **Wind in** . Spool most of the line onto the drum, ensuring tension during spooling.

**⚠** Leave enough line unspooled to be able to feed it through the sheave unit.

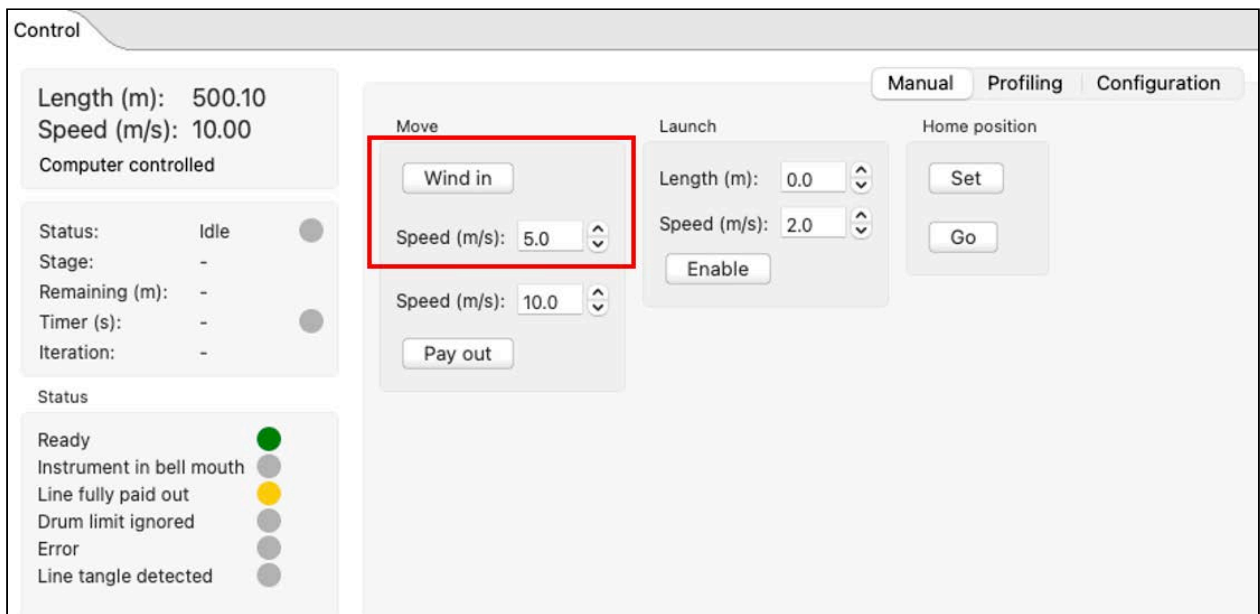

If you click once, the line will wind in bit by bit with each click. This is a safety feature which mimics how the handheld remote control unit operates.

If you click and hold, the line will run in continuously until you let go of the button.

**⚠** When using manual buttons, the winch moves at a constant speed. Stop winding in when the end of the line is close. Otherwise, the winch will feed the line into the drum and you will have to retrieve it.

2. Feed the line **through the sheave**: through the fairhead on the top of the unit, to the wheel, between the tensioner rollers, out of the bell mouth.



3. Shackle a weight to the end of the line.
4. Click **Pay out** . Unspool the entire length of the line into the water.  
If you click once, the line will pay out bit by bit with each click.  
If you click and hold, the line will run in continuously at the pay-out speed until it stops at the limit switch position.  
The **Status** will indicate, "Line fully paid out".

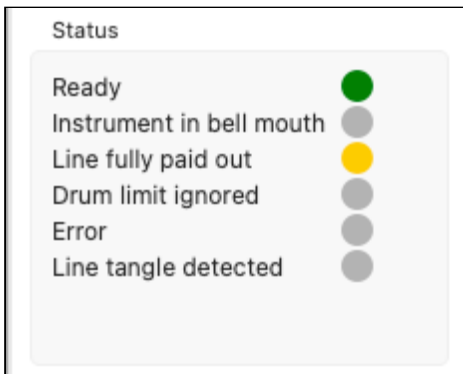

5. Click **Wind in** . Spool all the line back onto the drum, ensuring tension during spooling, until it stops.  
The **Status** will indicate, "Instrument in bell mouth".

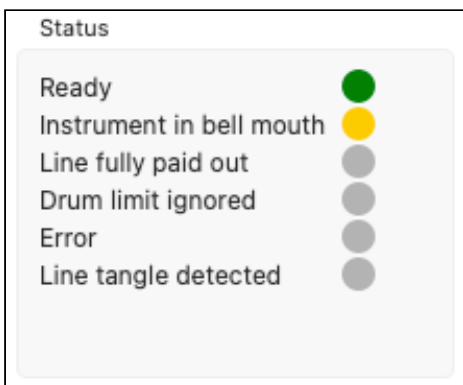

The line is ready for use.

## 13 Troubleshooting

Most issues that come up during operation of the RBR*glissando* can be easily fixed without contacting the support team. Refer to the cases below for guidance.

### 13.1 Error indicators on the winch

#### **RESET light is on**

**Possible cause:** Error when powering the winch.

**Solution:** Push to reset.

If it remains on after the reset, check if the handheld remote control unit is on.

If it is, check if the **Emergency stop** button is activated on either unit. If it is, confirm that the emergency has been addressed, and then twist the **Emergency stop** button to disable the alarm.

Push **Reset** on the handheld remote control unit or **RESET** on the control cabinet. Reset indicators should turn off on both units.

If not, turn the winch off and on again.

#### **Up / Down LED is blinking rapidly**

**Possible cause:** Line tangled error.

**Solution:** Inspect the drum unit for an entangled line. Untangle the line and push **Reset**.

#### **Up / Down LED is blinking slowly**

**Possible cause:** Non-critical error.

**Solution:** Turn the winch off and on again.

 If you have tried the recommendations above and the RBR*glissando* still does not function as expected, contact our support team at [support@rbr-global.com](mailto:support@rbr-global.com) or via the [RBR website](#).

## 13.2 Error indicators on Ruskin

### Line tangle detected

At a rare event of the line becoming entangled during operation, the RBR*glissando* will trigger an emergency stop, and the **Status** on Ruskin will indicate, "Line tangle detected". There will also be the **Clear line error** button displayed under the **Status** section.

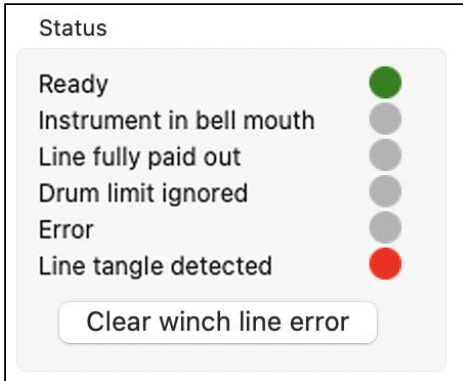

**Solution:** Inspect the drum unit, untangle the line, and click **Clear line error** to reset the winch.

### Instrument in bell mouth

A tangled line may also trigger the "Instrument in bell mouth" status. When this is the case, there will also be the **Clear line error** button displayed under to the **Status** section. Additionally, you will be able see the line still coming out of bell mouth.

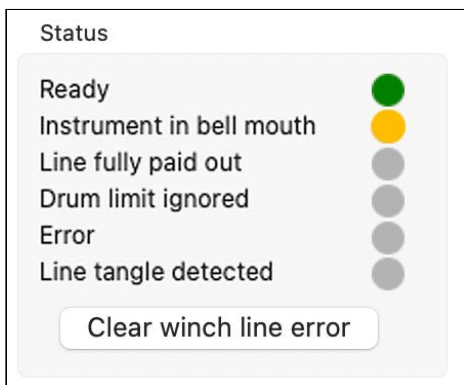

**Solution:** Manually pay out the line via Ruskin or using the handheld remote until the knot emerges from the bell mouth and you can reach it. Untangle the line and click **Clear line error** to reset the winch.

## Error

If the **Status** on Ruskin indicates, "Error" and/or displays a warning, a non-critical error was encountered during operation.

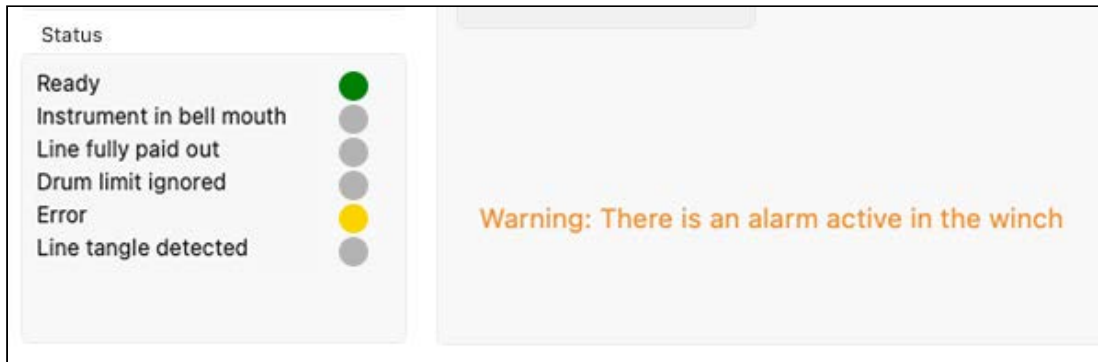

**Solution:** Turn the winch off and on again to clear the error.

## Connection to Ruskin lost

If connection to Ruskin is lost, the winch will stop.

**Solution:** Switch to **LOCAL** on the handheld remote control unit for manual operation. The white LED will be on continuously (no blinking). Use **UP** and **DOWN** buttons on the [handheld remote control unit](#) to control the winch.



**!** If you have tried the recommendations above and the RBR*glissando* still does not function as expected, contact our support team at [support@rbr-global.com](mailto:support@rbr-global.com) or via the [RBR website](#).

## 14 Revision history

Revision No.	Release Date	Notes
A	30-September-2023	Initial release

