

# RBR *quartz*<sup>3</sup> APT INSTRUMENT GUIDE



[rbr-global.com](http://rbr-global.com)

# Table of contents

1	RBR <i>quartz</i> <sup>3</sup> APT .....	3
2	Specifications .....	4
3	Deployment .....	7
3.1	RBR <i>quartz</i> <sup>3</sup> APT with Ethernet .....	7
3.2	RBR <i>quartz</i> <sup>3</sup> APT with RS-232 or RS-485 .....	8
4	Hardware .....	9
4.1	Opening and closing the instrument .....	9
4.2	RBR <i>quartz</i> <sup>3</sup> APT interface .....	13
4.3	Orientation and datum location .....	15
5	General maintenance .....	16
5.1	Support kit.....	16
5.2	Replacing the O-rings.....	17
5.3	Replacing the batteries.....	19
5.4	Replacing the desiccant capsules .....	21
5.5	Cleaning the instrument.....	23
5.6	Calibrating the instrument .....	23
6	Pressure sensor maintenance .....	24
6.1	Removing the antifouling mesh assembly.....	24
6.2	Filling the syringe and de-gassing the buffer oil.....	25
6.3	Cleaning the buffer tube .....	26
6.4	Refilling the buffer oil.....	27
7	External pressure adaptor .....	30
8	Repairs.....	31
9	Revision history .....	32

# 1 RBRquartz<sup>3</sup> APT

The RBRquartz<sup>3</sup> APT (Accelerometer, Pressure, Temperature) combines a triaxial quartz accelerometer with the Paroscientific Digiquartz<sup>®</sup> pressure sensor, building on the capabilities of the RBR bottom pressure recorders.

The instrument is designed for rapid ROV deployment, and penetrates the seabed to ensure good seismic coupling and insulation from potential noise sources. The RBRquartz<sup>3</sup> APT supports both autonomous installation and realtime data streaming to cabled observatories. The sub-second integration time consumes less power during sampling, significantly extending the time until the next battery replacement.

The RBRquartz<sup>3</sup> APT is ideal for ocean bottom earthquake and tsunami early detection and monitoring.

Key features of the RBRquartz<sup>3</sup> APT are:

- Long deployments
- High accuracy
- Quartz stability
- 10ppb pressure resolution
- 16Hz strong- and weak-motion accelerometer
- TCP/IP socket over Ethernet\*

\*Available upon request.

For a detailed description of bottom pressure recording using the RBRquartz<sup>3</sup> APT, refer to the [Ruskin User Guide: Standard loggers<sup>3</sup>](#).

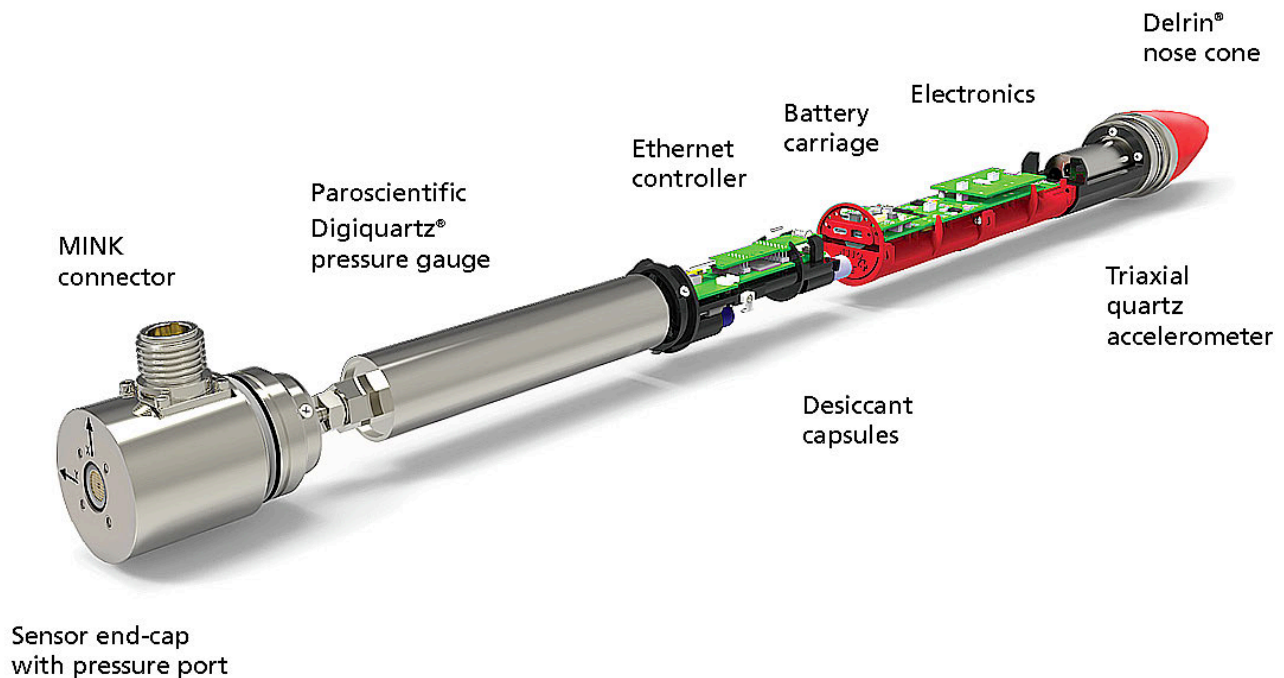

**RBRquartz<sup>3</sup> APT**

## 2 Specifications

### Instrument

Specification	Description
Storage	240 million readings*
Power	8 AA-type cells
External power	4.5V to 30V
Communications	Internal: USB-C External: USB and RS-232/RS-485, or Ethernet
Clock drift	±60 second/year
Max depth rating	7000m
Housing	Titanium
Diameter	60mm
Length	880mm (with Ethernet)**
Weight	5.7kg in air, 3.2kg in water (with Ethernet)**

\*Each sample can include multiple readings.

\*\*Length and weight depend on configuration. Non-Ethernet versions have slightly different lengths and weights.

### Temperature sensor

Specification	Description
Range	-2°C to 45°C
Initial accuracy	±0.002°C
Resolution	0.00005°C
Typical stability	±0.002°C/year
Time constant	~30s (embedded)

### Pressure sensor

Specification	Description
Range	4000 / 7000dbar
Initial accuracy	±0.01% full scale
Resolution	10ppb (at 1Hz sampling rate)
Thermal sensitivity	<0.0008% full scale per °C

## Accelerometer

Specification	Description
Range	±3g
Resolution	<100ng

## Power supply selection

If connected, an external power supply will be used preferentially over the internal batteries as long as the voltage remains 9V or greater. If it drops below 9V or complete disconnection occurs, the system automatically switches to the internal batteries.

## Power consumption

When the external power is present, the power consumption is ~1.5W continuous with an Ethernet connection and ~66mW with a serial connection.

## Clock

The instrument's clock is maintained during brief disconnections. This time is usually sufficient to change batteries or replace desiccants.

## USB-C power

The USB-C cable provides power sufficient for configuration or data download. However, the instrument requires an internal or external power supply to perform sampling.

## Deployment estimates

Deployment times are estimated for lithium thionyl chloride batteries based on both memory and internal battery capacity.

Speed	Time (days)	# of samples
16Hz	27	~38 million
8Hz	32	~22 million
4Hz	32	~11 million
2Hz	32	~6 million
2s	35	~2 million

**External MINK-10-FCR connector pinout**

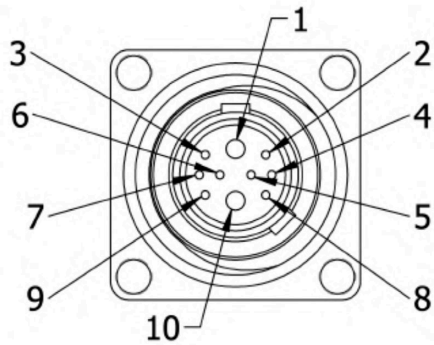

Pin No.	RS-232	RS-485	Ethernet
1	Power 4.5V to 30V		
2	N/C	RD(A)	Data output from the instrument (Tx+)
3	N/C	N/C	Data input into the instrument (Rx+)
4	Data output from the instrument (Tx)	RD(B)+	Data output from the instrument (Tx-)
5	Ground		
6	Data input into the instrument (Rx)	TD(B)+	N/C
7	N/C	N/C	Data input into the instrument (Rx-)
8	N/C		
9	N/C	TD(A)-	N/C
10	Ground		

## 3 Deployment

Deployment procedure of the RBRquartz<sup>3</sup> APT depends on whether its MINK connector is wired for Ethernet or for RS-232/RS-485. You will require a MINK cable and/or adaptor compatible with your instrument configuration. These are included with the instrument if requested at the time of order.

### 3.1 RBRquartz<sup>3</sup> APT with Ethernet

At the time of order, you can request your RBRquartz<sup>3</sup> APT wired for Ethernet and power. See the pinout diagram in the [Specifications](#) section.

**i** You do not need to open your instrument to connect it to your network. Follow the steps below.

#### Deploying RBRquartz<sup>3</sup> APT

1. Connect your terminal to the MINK port located outside the instrument body using a compatible MINK cable. The instrument will appear in your network.
2. The instrument will attempt to acquire network configuration information via DHCP.

**i** IP connections to the instrument are made on two different ports. The first one is the read-only data port (23) where you can listen for the measured data that is being streamed out. The other is the control port (2323) which permits some settings to be modified.

3. Upon connection to the control port (2323), there will be no immediate response or banner. You can enter commands by typing them in.

**i** When entering a command, terminate with linefeed. Any carriage returns will be ignored.

4. Enter the question mark ("?") command, terminated with linefeed, to display the network controller control menu. Any carriage returns will be ignored.

```
----- RBRquartz3 APT NETWORK INTERFACE CONTROL MENU -----  
  
D: Display current settings  
S: Set NTP source  
R: Set NTP refresh rate  
J: Set the timestamp jump tolerance  
E: Set the transparent mode inactivity timeout  
T: Enter transparent mode  
!: Exit transparent mode (once in transparent mode)  
Q: Close this connection  
#: Reset the RBRquartz3 APT network interface  
?: Print this menu
```

5. Enter "T" to enable the transparent mode.
6. Enter "clock" to reset the instrument clock if necessary.
7. Enter deployment parameters.

```
deployment starttime = 20000101000000, endtime = 20991231235959  
sampling mode = continuous, period = 63
```

8. Enter the following command to erase the memory and start the deployment.

```
enable erasememory = true
```

## 3.2 RBR*quartz*<sup>3</sup> APT with RS-232 or RS-485

At the time of order, you can request your RBR*quartz*<sup>3</sup> APT wired for RS-232/RS-485 and power. See the pinout diagram in the [Specifications](#) section.

 You do not need to open your instrument to connect it to Ruskin. Follow the steps below.

### Deploying the RBR*quartz*<sup>3</sup> APT

1. Connect your computer to the MINK port located outside the instrument body using a compatible MINK cable. The instrument will appear in Ruskin.
2. Select the required sampling mode and speed.
3. Select "UTC" or "Local" to synchronise the instrument clock to the computer.
4. Choose whether to start "now" or at a future point in time.
5. Review the estimated end date to ensure it fulfils the deployment requirements. Longer deployments can be achieved with better battery chemistry or lower sampling speeds.
6. Click "Enable" to start the deployment.



## 4 Hardware

### 4.1 Opening and closing the instrument



#### Opening the RBRquartz<sup>3</sup> APT



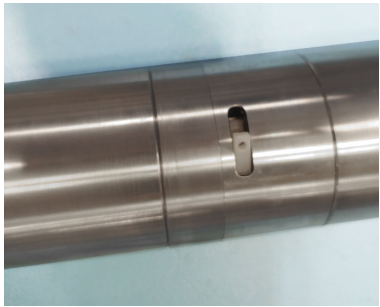

- ⚠ Do not attempt twisting the housing sections at any joint while the two halves of the instruments are together. The RBRquartz<sup>3</sup> APT has internal wires which may be damaged by such actions.

The only proper way of opening the RBRquartz<sup>3</sup> APT is to disconnect it in the middle into two halves first. Follow the steps below.



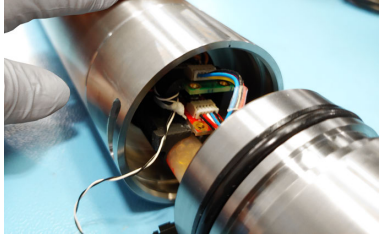

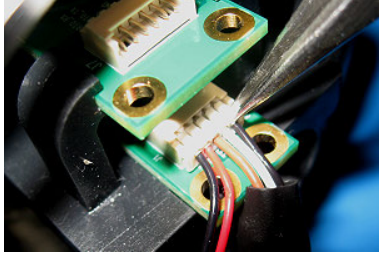

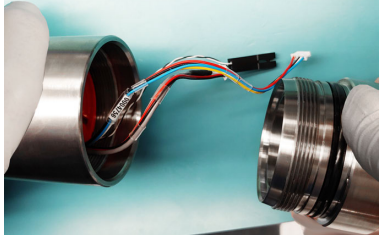

RBRquartz<sup>3</sup> APT

Step	Description	Images
1	Locate the nylon locking strap on the side of the instrument. The exposed edge has a hole in it.	
2	Using a pair of pliers, pull the nylon strap out of its locking groove.  <div data-bbox="280 1451 1063 1524" style="border: 1px solid gray; padding: 5px;"><p><b>i</b> It is normal to have a little silicone compound on this strap to help with its insertion/removal from the groove.</p></div>	

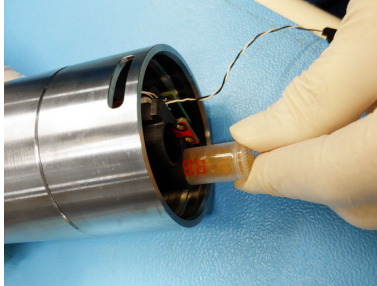
Step	Description	Images
3	Gently pull apart the two halves of the instrument. The wire assemblies allow for a gap of about 60mm.	
4	Remove the strain relief lacing tape and nylon straps from the wire assemblies.	
5	<p>Disconnect the wire assemblies:</p> <ol style="list-style-type: none"> <li>Using tweezers or plastic spudgers, gently wiggle the six-pin and five-pin connectors and pull them out from the PCBs.</li> <li>Hold the two parts of the two-pin connector with the tips of your fingers and pull them apart.</li> </ol> <div data-bbox="282 1171 1065 1222" style="border: 1px solid red; padding: 5px; margin-top: 10px;">  Never pull by the wires when separating the connectors. </div>	 
6	Once the wire assemblies are disconnected, the two halves of the RBRquartz <sup>3</sup> APT can now be handled independently.	

## Closing the RBRquartz<sup>3</sup> APT

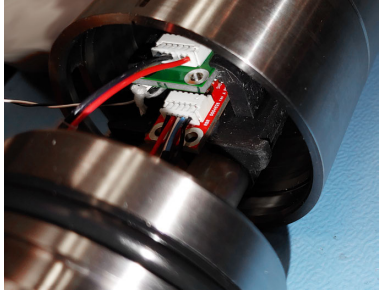
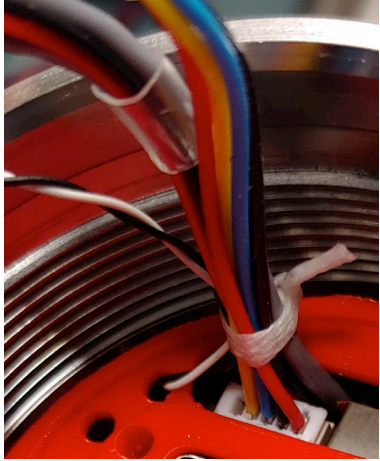
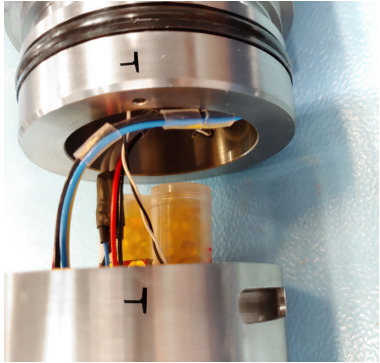
Step	Description	Images
1	Replace the two sets of O-rings which were exposed when the instrument was open.	
2	Screw the coupling back onto the instrument.	
3	Replace the desiccant capsules. Fresh desiccant is orange.	
4	Replace the batteries, ensuring correct polarity.	

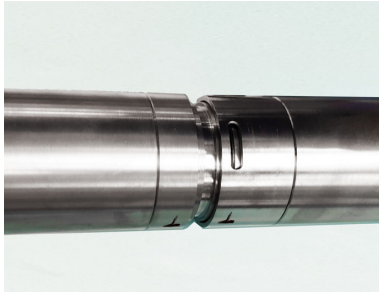
Step	Description	Images
5	<p>Reconnect the wiring, in this order:</p> <ol style="list-style-type: none"> <li>1. the five-pin connector to the small lower board</li> <li>2. the six-pin connector to the larger board</li> <li>3. the two-pin connector (two-wire connection)</li> </ol>	
6	<p>Put the strain relief lacing tape and nylon straps on the wire assemblies.</p>	
7	<p>With a removable marker, mark the location of the dowel pin on outside of the housing. Also, mark the location of the mating dowel pinhole on the outside of the coupler.</p>	
8	<p>Reassemble the two halves of the instrument:</p> <ol style="list-style-type: none"> <li>1. Align the markings.</li> <li>2. Make sure the dowel pin goes right into the hole.</li> <li>3. Gently push the two sections together.</li> <li>4. Inspect the joint, as O-rings may get snagged on the cutout for the strap.</li> </ol> <div style="border: 1px solid red; padding: 5px; margin-top: 10px;"> <p> If any O-ring debris is found, go to <b>Opening the RBRquartz<sup>3</sup> APT</b>, Steps 3-5, and replace the damaged O-ring. Then, go to <b>Closing the RBRquartz<sup>3</sup> APT</b>, Step 5, and continue with the re-assembly.</p> </div>	

Step	Description	Images
9	<p>Using pliers or your thumb, push the nylon locking strap into the slot all the way in, cut-off end first.</p> <p>The instrument is now closed.</p>	

## 4.2 RBRquartz<sup>3</sup> APT interface

The RBRquartz<sup>3</sup> APT instrument provides an internal USB-C port and several external communication options. Select from RS-232, RS-485, and Ethernet at the time of order, and RBR will wire the battery end-cap to support your preferred external connection.

**i** Refer to [Opening and closing the instrument](#) for details on accessing connection ports. Refer to [Specifications](#) for the external MINK-10-FCR connector pinout diagram.

### USB-C connection

Remove the battery end-cap to access the USB-C port located inside the instrument body.

A USB-C desktop cable is supplied in the instrument support kit. Use this cable to download data from the instrument to your computer.



**USB-C port**

**i** The mini-display port located next to the USB-C port is not used.

## MINK connector

The RBR*quartz*<sup>3</sup> APT instrument has an external MINK-10-FCR connector. The MINK interface provides both data and power connections and is located near the pressure sensor. The MINK data and power connections allow for extended deployments by providing external power and realtime data access without jeopardising the watertight seal.

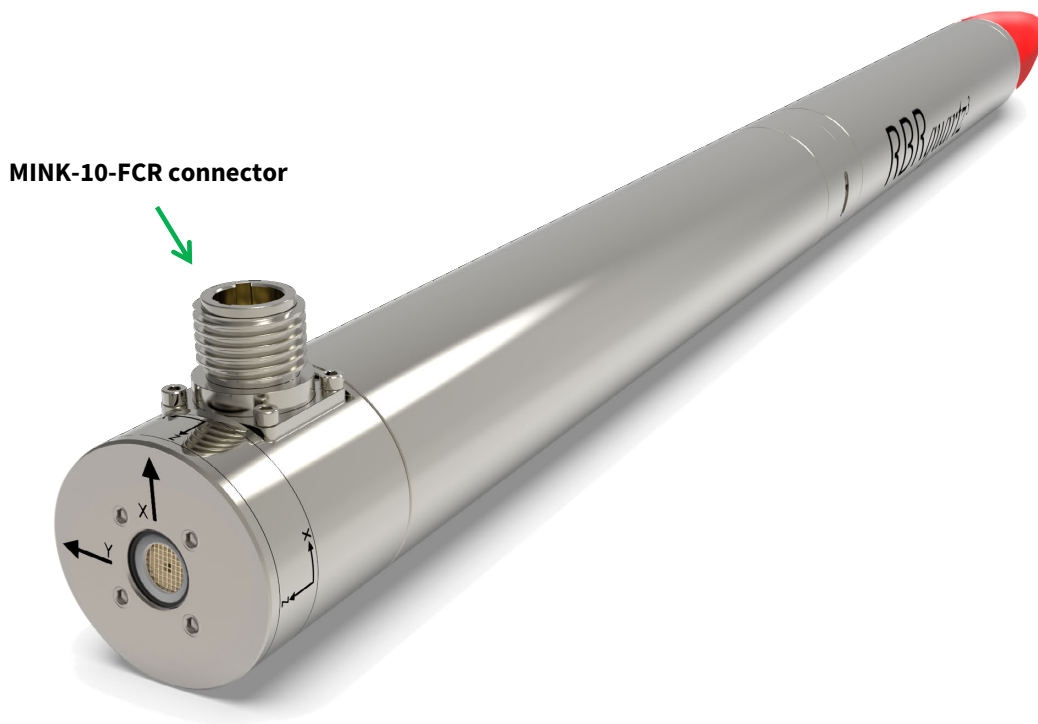

### 4.3 Orientation and datum location

The datum of the RBR*quartz*<sup>3</sup> APT is located at the centre of the pressure sensor port. RBR performs an offset adjustment with the sensor facing upwards. It is recommended to deploy the RBR*quartz*<sup>3</sup> APT vertically to match the way it was calibrated, with the nose cone of the instrument penetrating the seabed.



**Recommended orientation:  
sensors facing up**

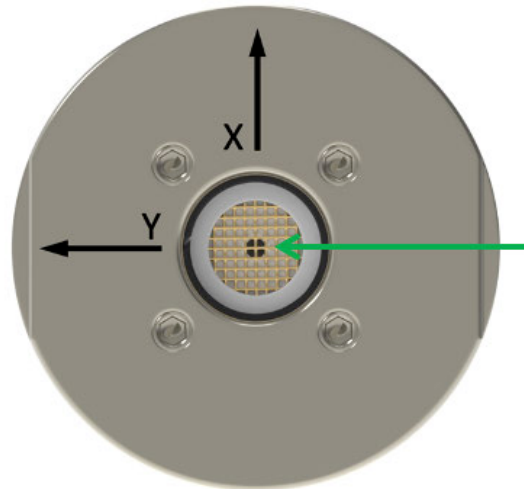

**Datum location**

# 5 General maintenance

## 5.1 Support kit



**RBRquartz<sup>3</sup> support kit**

RBR provides one support kit per every three instruments ordered. If you need more units, contact [RBR](#). The RBR support kit contains an assortment of basic accessories and spare parts, as presented below.

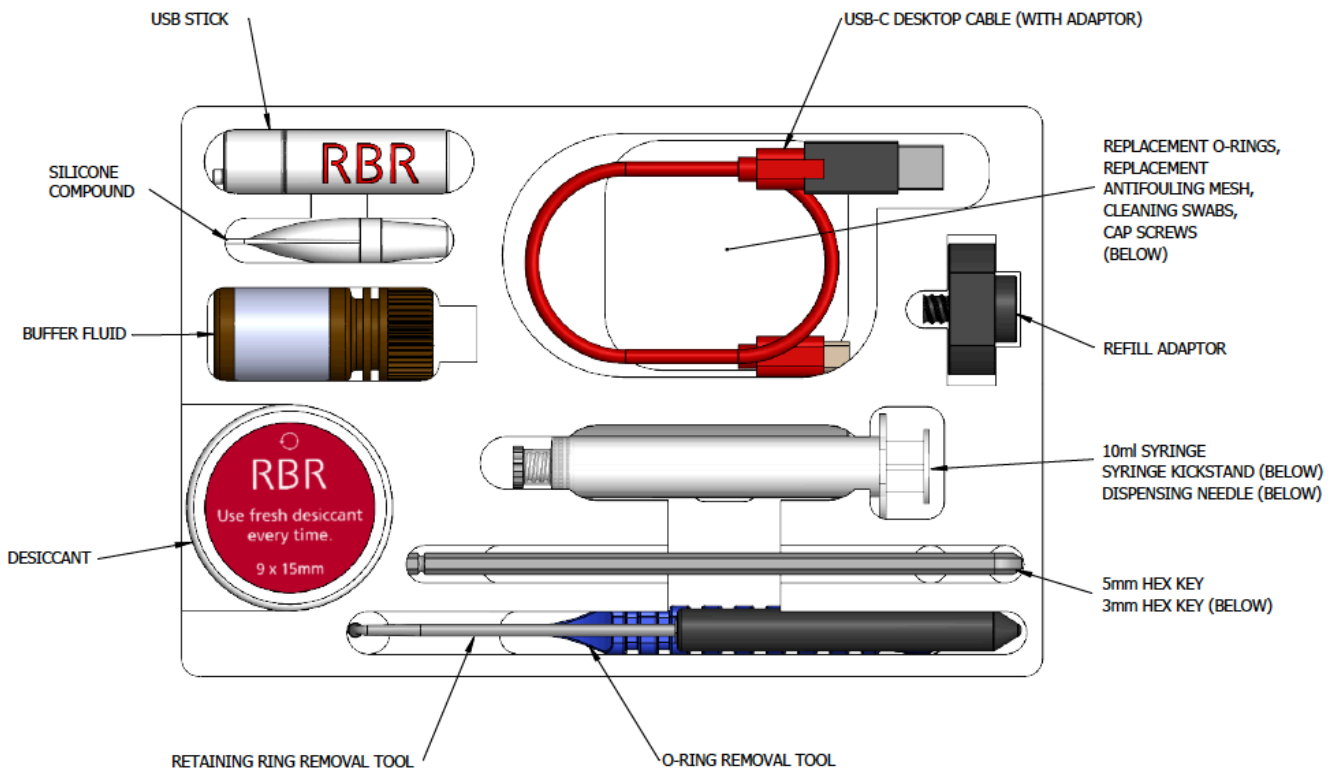

**RBRquartz<sup>3</sup> support kit diagram**



## 5.2 Replacing the O-rings

- i** Refer to [Opening and closing the instrument](#) for details on accessing the O-rings. The O-ring removal tool and silicone compound are available in the [support kit](#).

Care for the O-rings is the single most important item of maintenance on any submersible RBR instrument. A water leak can damage the circuit board beyond repair and cause complete data loss. Every instrument's seal depends upon its O-rings, not the end-cap tightness. Therefore, proper O-ring maintenance is crucial.

- i** The O-ring may lose elasticity over time, even when the instrument is not deployed. RBR strongly recommends replacing the O-ring regularly.

### O-rings on the RBRquartz<sup>3</sup> APT

The RBRquartz<sup>3</sup> APT instrument has a coupling piece, which connects the two halves of the instrument together. Each of the two joints uses two O-rings. One is the main O-ring, and the other is the backup. Both are required to protect the instrument from flooding.



**Location of the coupling piece on the RBRquartz<sup>3</sup> APT**

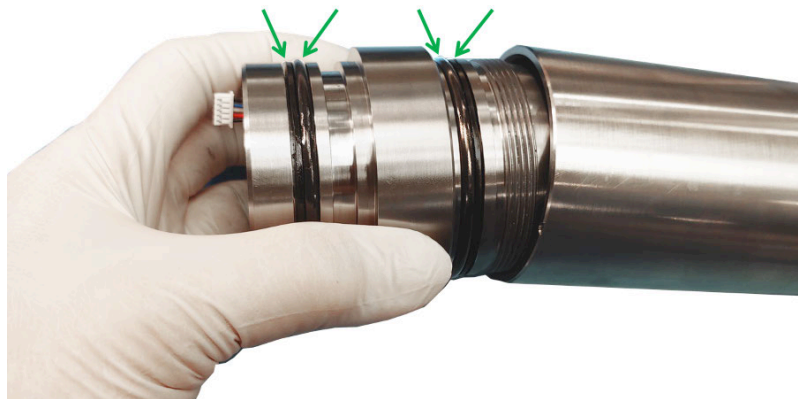

**Locations of the O-rings**

## Inspecting the O-rings

 Only the O-rings which were exposed during maintenance need to be checked before reassembly.

Visually inspect each new O-ring for nicks and scratches before installing it. Pay attention to the following areas:

- The surface of the O-ring itself
- The mating surface on the inside of the case between the threads and the open end
- The groove in the end-cap where the O-ring sits

 When handling the O-rings:

- Avoid using any object that could scratch the O-ring or any of its mating surfaces.
- If dirt is present in the O-ring groove, remove the O-ring as described below and thoroughly clean the groove.
- Do not return this old O-ring to the instrument! If you remove the O-ring from the instrument for any reason, always replace it with a new one.
- If the surfaces of the O-ring groove are scratched, pitted, or damaged, contact [RBR](#) for advice.

## Orientation of the O-rings

Correct placement and orientation of the two O-rings are critical to maintaining depth rating integrity.

The main O-ring has a round profile. It must be installed first.

The backup O-ring is flat on one side, and concave on the other. When installed, the concave side must face the main O-ring.

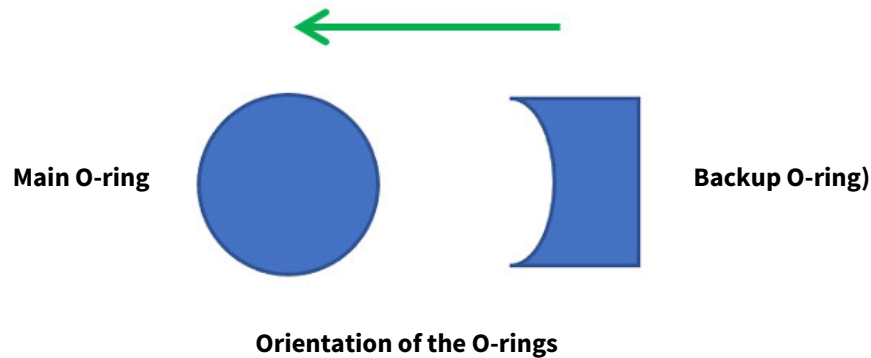

## Replacing the O-rings

**⚠** Do not use metal screwdrivers or any other metal tool! They may scratch the O-ring groove and render the end-cap useless.

1. Use the plastic O-ring removal tool (included in the support kit) to remove the old O-ring from its groove. The O-ring may need to stretch quite a bit as it is pushed off. This requires some effort, but can be done by hand.
2. Clean the groove thoroughly with a soft, lint-free cloth and compressed air, if necessary.
3. Select a new O-ring and inspect it for damage.
4. Lubricate with a very light film of silicone compound (included in the support kit).
5. Install the main O-ring by pushing it into place and popping it into its groove.
6. Install the backup O-ring, making sure the concave side is facing the main O-ring.
7. Once in place, inspect the O-rings once more for scratches and debris, and wipe away any excess of silicone compound.
8. Remove electrical tape from the threads.
9. Close the instrument.

## 5.3 Replacing the batteries

RBR ships new instruments with lithium thionyl chloride batteries included. Replace the batteries before each deployment to maximise the operational time and prevent data loss.





Ruskin software allows users to estimate the remaining battery life during deployment (assuming fresh batteries) by tracking power consumption in mAh. See [Ruskin User Guide: Standard Loggers<sup>3</sup>](#) for more information on predicting battery life.



The half of RBRquartz<sup>3</sup> APT with the battery carriage assembly

### Replacing the batteries

Step	Description	Images
1	<p>Open the instrument and disconnect the wiring.</p> <p><b>i</b> The half of the instrument with the nose cone contains the battery carriage assembly.</p>	

Step	Description	Images
2	Unscrew the coupling piece to expose the battery carriage assembly.	
3	Push on the arrow to open the battery door.	
4	Remove eight old batteries.	
5	Install eight new AA-type batteries, with the negative ends down.	

Step	Description	Images
6	Close the battery door.	
7	Replace the O-rings on the coupling section. Lubricate with a small amount of silicone compound.	
8	Inspect the threads on the housing and on the coupling piece to ensure they are clean and undamaged.	
9	Screw the coupling piece back onto the housing.	
10	Reconnect the wiring and close the instrument.	

## 5.4 Replacing the desiccant capsules

Replace desiccant capsules before each deployment.

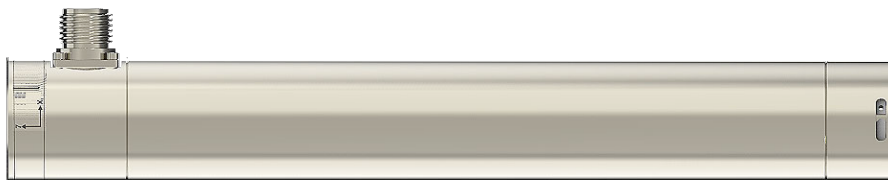

Fresh desiccant will keep the instrument compartment dry and prevent malfunction. Water damage may occur if condensation forms inside the instrument.

As a preventative measure, RBR recommends servicing the instrument in a cool, dry place (when possible).

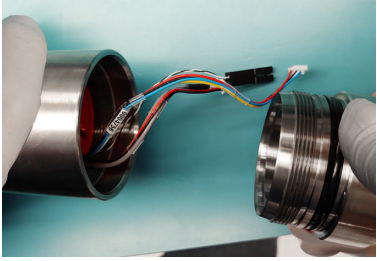

**The half of RBRquartz<sup>3</sup> APT with the desiccant capsules**

## Replacing the desiccant capsules

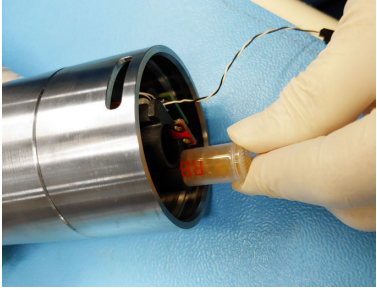
Step	Description	Images
1	<p>Open the instrument and disconnect the wiring.</p> <div data-bbox="284 373 1063 445" style="border: 1px solid gray; padding: 5px;"><p> The half of the instrument with the MINK connector contains desiccant capsules.</p></div>	
2	<p>Pull the used capsules out of the desiccant socket.</p>	
3	<p>Insert two fresh desiccant capsules.</p>	
4	<p>Reconnect the wiring and close the instrument.</p>	

## 5.5 Cleaning the instrument

Clean the instrument after each extended deployment to remove deposits that may have accumulated.

Type	Procedure	Notes
General/biofouling	To clean the exterior, soak in a mild detergent, then scrub the instrument with a soft brush.	Avoid scratching the plastic (scratches make future cleaning more difficult).
Sensor antifouling mesh	Scrub the antifouling mesh with a soft brush. Replace the antifouling mesh if needed.	See instructions on removing the antifouling mesh for more information.
Calcification	Soak in vinegar for six hours, then scrub the surface using a soft brush.	Soaking in vinegar for more than 24 hours may damage the O-ring and increase the chances of a leak.

## 5.6 Calibrating the instrument

Factory calibration coefficients are calculated for each sensor, and the coefficients are stored on the instrument.

RBR calibration certificates contain calibration equations, coefficients, and residuals for each sensor. Hard copies are provided with each shipment. RBR can replace lost or misplaced calibration certificates upon request.

RBR recommends calibrating your instrument before any critical deployment, periodically once a year, or if you suspect the readings to be out of specifications.

Discuss your calibration requirements with RBR. In some cases, the instrument will need to be returned to RBR to have it checked and re-calibrated.







Please contact [RBR](#) for our current calibration fees.

## 6 Pressure sensor maintenance

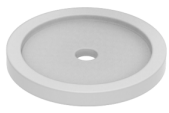
### 6.1 Removing the antifouling mesh assembly

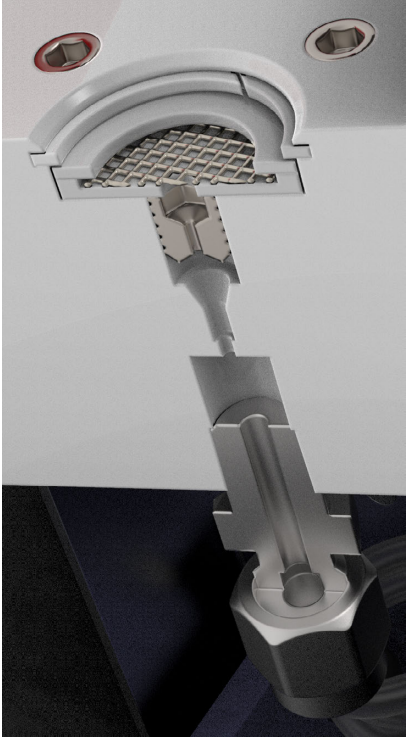
Removing the antifouling mesh assembly may be necessary for a variety of reasons, such as cleaning the instrument and its buffer tube, or installing the external pressure adaptor. Follow the steps below.

1. Remove the retaining ring using the removal tool. Hook the split in the ring at the opening and pull it out of the recess in the sensor end-cap.
2. The upper mesh insulator disk, nickel-copper mesh, and the lower mesh insulator disk will come out easily once the retaining ring is removed.

Item No.	Description	Part image	Assembled antifouling mesh	Buffer tube interface assembly
1	Lower mesh insulator disk			
2	Nickel-copper mesh			
3	Upper mesh insulator disk			
4	Retaining ring			



## 6.2 Filling the syringe and de-gassing the buffer oil

It is important to remove all gases from the system as they can form bubbles and cause anomalies in the data. Refill the system with de-gassed oil any time when cleaning it, or if it has had an oil leak for any reason.

### Required materials

- Buffer fluid
- Syringe with a stopper and needle
- Syringe kickstand

### Recommended handling materials

- Latex or nitrile gloves
- Lint-free tissues
- Protective coat

**⚠** Buffer oil is not a hazardous substance, but it is recommended to practice good industrial hygiene and safety practices, and to use this material in a well-ventilated space.

### Filling the syringe

Step	Description
1	Remove the stopper from the syringe.
2	Install the needle.
3	Draw 1-2ml of the oil into the syringe.

### De-gassing the buffer oil

Step	Description	Image
1	Invert the syringe so that the needle is facing up and pull any remaining oil out of the needle into the syringe.	
2	Remove the needle.	
3	Gently push the plunger to purge the air from the syringe.	
4	Install the stopper.	
5	Reverse the syringe so that the stopper is facing down.	
6	Draw out the plunger of the syringe past the 10ml point.	
7	Install the syringe kickstand so that it cups the plunger and supports it in the drawn-out position. The syringe will brace against the flange on the plunger and the barrel.	
8	Leave the syringe in the reverse position for about an hour.	
9	Remove the kickstand.	
10	Invert the syringe so that the tip is facing up.	
11	Remove the stopper.	
12	Purge any air from the syringe	



## 6.3 Cleaning the buffer tube

**i** All required materials for this procedure are provided in the [support kit](#).

### Required materials

- Buffer fluid
- Syringe with a stopper and needle
- Syringe kickstand

### Cleaning the buffer tube by aspirating the buffer oil

Step	Description	Images
1	Remove the antifouling mesh assembly	
2	<p>Clean the buffer tube assembly</p> <ol style="list-style-type: none"> <li>1. Insert the needle into the buffer tube assembly, all the way</li> <li>2. Draw out the plunger of the syringe past the 10ml point</li> <li>3. Install the syringe kickstand so that it cups the plunger and supports it in the drawn-out position; the syringe will brace against the flange on the plunger and the barrel</li> </ol> <div style="border: 1px solid orange; padding: 5px; margin-top: 10px;"> <p><b>⚠</b> The syringe will draw up oil and any particles until the assembly is empty, and then, it will draw air.</p> </div>	 
3	Refill the buffer tube assembly	

### Cleaning the buffer tube by purging with buffer oil

Debris can be removed from the buffer tube assembly by purging the assembly with buffer oil. This method will consume more oil, but it may be more effective in some situations.

Step	Description
1	<p>Prepare the instrument and the syringe</p> <ol style="list-style-type: none"> <li>1. Remove the antifouling mesh assembly</li> <li>2. Remove the instrument from the foam stand and lay it on its side</li> <li>3. Fill the syringe and de-gas the buffer oil</li> </ol>
2	<p>Clean the buffer tube assembly</p> <ol style="list-style-type: none"> <li>1. Insert the needle into the buffer tube assembly, all the way</li> <li>2. Depress the plunger and flush the buffer tube assembly</li> <li>3. With the syringe still in the pressure port, stand the instrument with the port up</li> <li>4. While depressing the plunger, remove the syringe</li> </ol>
3	Refill the buffer tube assembly



## 6.4 Refilling the buffer oil



 All required materials for this procedure are provided in the [support kit](#).



### Required materials

- 3mm and 5mm hex keys
- O-ring
- Silicone compound
- Buffer fluid
- Syringe with a stopper and needle
- Syringe kickstand
- Refill adaptor
- Four socket head cap screws

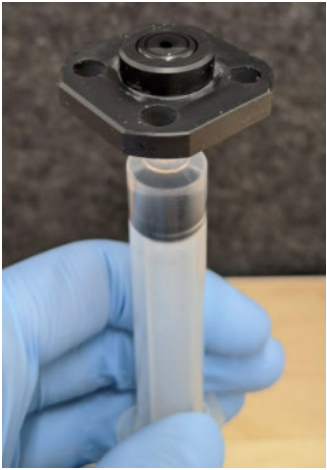
### Refilling the buffer oil

Step	Description	Images
1	<p>Prepare the instrument</p> <ol style="list-style-type: none"><li>1. Remove the antifouling mesh assembly (see <a href="#">Removing the antifouling mesh assembly</a>)</li><li>2. Remove the four set screws around the pressure port using the 3mm hex key</li></ol>	 A photograph of a cylindrical metal instrument. The front face has a central circular port with a small arrow pointing upwards. Four screws are arranged around this port. Below the instrument, the four screws, a small circular O-ring, and two larger circular gaskets are laid out.
2	<p>Prepare the refill adaptor</p> <ol style="list-style-type: none"><li>1. Apply a thin film of silicone compound to the O-ring of the refill adaptor</li><li>2. Install the O-ring into the refill adaptor as shown in the image</li></ol>	 A photograph of a black, octagonal metal refill adaptor. It has a central circular opening with a smaller inner circle. An O-ring is seated in a groove around the inner circle.

Step	Description	Images
3	<p>Fill the buffer tube with oil</p> <ol style="list-style-type: none"> <li>1. Remove the stopper from the syringe</li> <li>2. Install the needle</li> <li>3. Invert the syringe so that the needle is point up</li> <li>4. Purge the air from the needle by depressing the plunger until a drop of oil comes out</li> <li>5. Insert the needle into the buffer tube assembly and fill it with oil to the top of the set screw</li> <li>6. When extracting the needle, continue to apply pressure to the plunger to maintain the oil level</li> <li>7. Draw the oil out of the needle and remove the needle</li> </ol>	
4	<p>Refilling the oil</p> <ol style="list-style-type: none"> <li>1. Install the refill adaptor to the syringe</li> <li>2. Invert the syringe so that the refill adaptor is pointing up</li> <li>3. Purge the air from the refill adaptor by depressing the plunger until a drop of oil sits at the adaptor opening</li> </ol> <div style="border: 1px solid orange; padding: 5px; margin-top: 10px;"> <p><b>⚠</b> Ideally, the meniscus at the air-oil interface should be convex to minimise the air in the final assembly.</p> </div>	
5	<p>Install the refill adaptor</p> <ol style="list-style-type: none"> <li>1. Mate the refill adaptor to the pressure port</li> <li>2. Install the four cap screws with the 5mm hex key</li> </ol> <div style="border: 1px solid red; padding: 5px; margin-top: 10px;"> <p><b>⚠</b> Do not apply pressure to the plunger when the syringe is installed on the pressure port! Doing so may exceed the pressure rating of the sensor.</p> </div>	

Step	Description	Images
6	<p>De-gas the system</p> <ol style="list-style-type: none"> <li>1. Draw the plunger of the syringe just past the 10ml mark</li> <li>2. Install the syringe kickstand so that it cups the plunger and supports it in the drawn-out position; the syringe will brace against the flange on the plunger and the barrel</li> </ol> <div data-bbox="318 380 1094 531" style="border: 1px solid orange; padding: 5px; margin: 10px 0;"> <p><b>⚠</b> Bubbles will be coming out of the system through the oil into the syringe, drawn into the rarefied air. The rate of bubbles coming out should quickly start to reduce. If it is not happening, tighten the syringe to the refill adaptor and tighten the four cap screws.</p> </div> <ol style="list-style-type: none"> <li>3. Leave the syringe in this position for about an hour</li> <li>4. Remove the kickstand, while keeping the syringe in place</li> </ol> <div data-bbox="318 659 1094 730" style="border: 1px solid orange; padding: 5px; margin: 10px 0;"> <p><b>⚠</b> The plunger will drop back, almost to the surface of the oil, due to low pressure inside the syringe.</p> </div> <ol style="list-style-type: none"> <li>5. With everything still attached, draw the plunger of the syringe just past the 10ml mark again</li> <li>6. Very gently pump the plunger up and down approximately 10 times, until no bubbles come out of the system after drawing the plunger .</li> </ol>	
7	<p>Clean up and reassemble</p> <ol style="list-style-type: none"> <li>1. Remove the refill adaptor</li> <li>2. Remove excess oil from the pressure port with a tissue or swab</li> <li>3. Once cleaned, install the lower mesh insulator disk with the recess facing up</li> <li>4. Place the nickel-copper mesh in the recess of the lower mesh insulator disk</li> <li>5. Place the upper lower mesh insulator disk on top of the lower mesh insulator disk and nickel-copper mesh assembly</li> <li>6. Open the split on the retaining ring and ease its middle into the sensor end-cap recession</li> <li>7. Hold the retaining ring in place with one finger and feed the the rest of the ring into the sensor end-cap recession</li> </ol>	

## 7 External pressure adaptor

The external pressure adaptor is designed for the RBR*quartz*<sup>3</sup> instruments and can be used to verify or recalibrate the Paroscientific Digi*quartz*<sup>®</sup> pressure sensor.

RBR provides the RBR*quartz*<sup>3</sup> pressure adaptor kit with each instrument. It is not included in the RBR support kit and needs to be ordered separately. You can choose to receive this separate kit at the same time as the instrument, or to request it separately at a later date.

RBR*quartz*<sup>3</sup> pressure adaptor kit includes:

- pressure adaptor
- four socket head cap screws
- 3mm and 5m hex keys
- five replacement O-rings

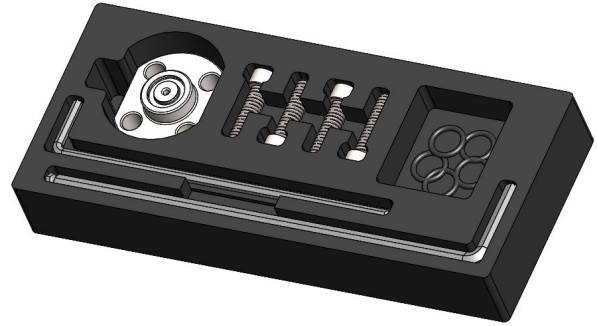

**Pressure adaptor kit**

### Installing the adaptor

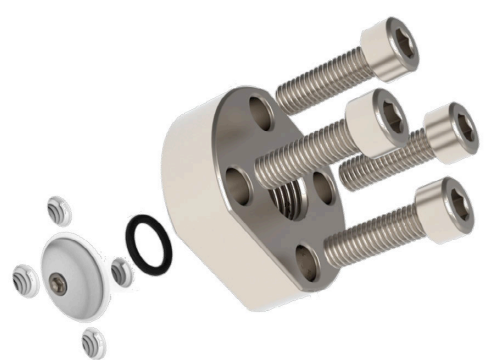
Step	Description	Image
1	Remove the antifouling mesh.	
2	Apply a thin layer of silicon compound to the O-ring.	
3	Install the O-ring into the O-ring groove of the external pressure adaptor.	
4	Position the external pressure adaptor over the exposed pressure port of the instrument.	
5	Install the four screws with a 5mm hex key and tighten them to 1/4 turn past snug (max 10 Nm torque).	

## 8 Repairs

RBR supports all our products. Contact us immediately at [support@rbr-global.com](mailto:support@rbr-global.com) or via the [RBR website](#) if there are any issues with your instrument. Please have the model and the serial number of the unit ready. Our support team will work to resolve the issue remotely. In some cases, you may have to return your instrument to RBR for further servicing.

 There are no user-repairable parts of the instrument. Any attempt to repair without prior authorisation from RBR will void the warranty. Refer to the [RBR warranty statement](#).

To return a product to RBR for an upgrade, repair, or calibration, please contact our [support team](#) to obtain a return merchandise authorisation code (RMA) and review the detailed shipping information on the [RBR website](#).

## 9 Revision history

Revision No.	Release Date	Notes
A	15-May-2022	Original

